

Battery and Charging System - General Information - Battery Care Requirements

Description and Operation

1. INTRODUCTION

This document defines the requirements for care and maintenance of batteries, and the standard of battery care at dealers and retailers for new vehicles.

This applies to all types of 12 Volt Lead Acid Batteries used in Jaguar and Land Rover vehicles whether they are conventional flooded technology or Absorbed Glass Mat (AGM – also known as Valve Regulated Lead Acid (VRLA)) technology and also applies to both Primary, Secondary and Auxiliary Batteries. AGM batteries offer improved resistance to cycling as seen in stop start applications.

In order to prevent damage to the battery and ensure a satisfactory service life, all processes detailed within this document must be rigorously adhered to.

It is equally important therefore to note the following key points:

- All new vehicles leave the factory with either a transit relay installed and/or have a transit mode programmed into the vehicle control modules. The transit relay must be removed and the transit mode disabled (where applicable) using an approved diagnostic system, **NOT MORE THAN 72 HOURS** before the customer takes delivery.
- The battery can be discharged by the following mechanisms:
 - **Self Discharge:** - A lead acid battery will very slowly discharge itself due to its own internal chemical processes whether it is connected to a vehicle or not.
 - **Quiescent Discharge:** - The vehicle electrical systems when connected to the battery will draw charge from the battery.

12 Volt Lead Acid Batteries rely on internal chemical processes to create a voltage and deliver current. These processes and the internal chemical structure of the battery can be damaged if the battery is allowed to discharge over a number of weeks / months, or is left in a discharged state for a lengthy time period.

- **On vehicles with conventional ignition keys**, these must not be left in the ignition lock barrel when the transit relay has been removed, otherwise quiescent current will increase and the battery will discharge more rapidly.
- **For keyless vehicles**, the Smart Key must be stored at least 5m (16 ft) away from the vehicle when the vehicle is parked or stored.
- **AGM Batteries are fully sealed and cannot have the electrolyte level topped up.**



NOTE: Dealers and retailers involved in the storage / handling of vehicles and replacement batteries have a responsibility to ensure that only a fully charged battery may be processed through the distribution selling chain.

2. GENERAL RULES FOR BATTERY CARE

2.1 Dealer Demonstration Vehicles

Vehicles used as dealer demonstrator(s), in a showroom, must be connected to a JLR approved showroom conditioner capable of delivering 50 Amps. This will prevent the battery from being damaged.

2.2 Software Reflash, SDD work or Ignition On related workshop activities

Due to the high electrical current demand and high depth of discharge that can occur during vehicle software re-flash activities, SDD work or ignition on (power mode 6) related work in the workshop, vehicles that are undergoing such activities MUST have a JLR approved power supply capable of delivering 50 Amps or more.

2.3 Extended Vehicle Rework

For any extended vehicle rework that results in consuming vehicle power, either the battery should be disconnected or a JLR approved power supply connected.

2.4 Jump Starting New vehicles before they have been delivered to the customer

- It is the dealer / retailers responsibility to make sure the battery is not allowed to discharge by following the instructions and processes defined in this manual.
- However, if circumstances dictate that a new vehicle must be jump started due to a discharged battery whilst the vehicle is in the dealer / retailers care, **the battery on this vehicle must be replaced with a new one** prior to delivery to the customer at the dealer / retailers liability.
- The vehicle should also undergo investigation as to why the battery became discharged.
- Do not connect the jump starting cable to the negative (-) terminal of the battery. Always connect to the recommended earth point. As defined in the owners handbook or service documentation for that vehicle.

2.5 AGM Batteries

- **AGM batteries must not be charged above 14.8 Volts. Doing so will damage them.**
- AGM Batteries must be tested with a capable battery tester as **detailed in the Equipment section (Section 5) of this**

procedure.



NOTE: Under no circumstances should the battery be disconnected with the engine running because under these conditions the generator can give a very high output voltage. This high transient voltage will damage the electronic components in the vehicle. Loose or incomplete battery connections may also cause high transient voltage.

3. HEALTH AND SAFETY PRECAUTIONS

WARNINGS:



BATTERY CELLS CONTAIN SULPHURIC ACID AND EXPLOSIVE MIXTURES OF HYDROGEN AND OXYGEN GASES. IT IS THEREFORE ESSENTIAL THAT THE FOLLOWING SAFETY PRECAUTIONS ARE OBSERVED.



Batteries emit highly explosive hydrogen at all times, particularly during charging. To prevent any potential form of ignition occurring when working in the vicinity of a battery:

- Do not smoke when working near batteries.
- Avoid sparks, short circuits or other sources of ignition in the battery vicinity.
- Switch off current before making or breaking electrical connections.
- Ensure battery charging area is well ventilated.
- Ensure the charger is switched off when: a) connecting to a battery; b) disconnecting from the battery.
- Always disconnect the ground cable from the battery terminal first and reconnect it last.



Batteries contain poisonous and highly corrosive acid. To prevent personal injury, or damage to clothing or the vehicle, the following working practices should be followed when topping up, checking electrolyte specific gravity, removal, refitting or carrying batteries:

- Always wear suitable protective clothing (an apron or similar), safety glasses, a face mask and suitable gloves.
- If acid is spilled or splashed onto clothing or the body, it must be neutralized immediately and then rinsed with clean water. A solution of baking soda or household ammonia and water may be used as a neutralizer.
- In the event of contact with the skin, drench the affected area with water. In the case of contact with the eyes, bathe the affected area with cool clean water for approximately 15 minutes and seek urgent medical attention.
- If battery acid is spilled or splashed on any surface of a vehicle, it should be neutralized and rinsed with clean water.
- Heat is generated when acid is mixed with water. If it becomes necessary to prepare electrolyte of a desired specific gravity, SLOWLY pour the concentrated acid into water (not water into acid), adding small amounts of acid while stirring. Allow the electrolyte to cool if noticeable heat develops. With the exception of lead or lead-lined containers, always use non-metallic receptacles or funnels. Do not store acid in excessively warm locations or in direct sunlight.



Due to their hazardous contents, the disposal of batteries is strictly controlled. When a battery is scrapped, ensure it is disposed of safely, complying with local environmental regulations. If in doubt, contact your local authority for advice on disposal facilities.

4. BATTERY CARE REQUIREMENTS

4.1 RECEIPT OF A NEW VEHICLE

Within 24 hours of receipt of a new vehicle, a battery condition check must be carried out in accordance with the battery test process utilizing a JLR approved tester as outlined in **the Equipment section (Section 5) of this procedure**.



NOTE: The Midtronics code from the tester must be recorded on the form.

Any actions must be carried out in accordance with the table shown in the **Determining Battery Condition section (Section 6) of this procedure**. The details must be recorded on the New Vehicle Storage Form which is part of the new vehicle storage document.

For additional information, refer to: [New Vehicle Storage Form](#) (100-11 Vehicle Transportation Aids and Vehicle Storage, Description and Operation).

4.2 NEW VEHICLE STORAGE

If the vehicle is to be stored the transit relays MUST be refitted and / or the vehicle put into transport mode.

Transit relay removal / vehicle placed in normal mode should only be completed a maximum of 72 hours prior to handover to customer

For vehicles without either a transit mode or transit relay the battery negative cable must be DISCONNECTED from the battery.

The battery must be tested and/or re-charged every 30 days and MUST be re-charged after every 90 day period.



NOTE: The Midtronics code from the tester must be recorded on the form.

Any actions must be carried out in accordance with the table shown in the **Determining Battery Condition section (Section 6) of this procedure**. The details must be recorded on the New Vehicle Storage Form which is part of the new vehicle storage document.

For additional information, refer to: [New Vehicle Storage Form](#) (100-11 Vehicle Transportation Aids and Vehicle Storage, Description and Operation).

4.3 PDI / DELIVERY TO CUSTOMER

Before the vehicle is handed over to the customer and as part of the PDI, the condition of the battery needs to be confirmed. The battery condition must be checked in accordance with the battery test process utilizing a JLR approved tester as outlined in **the Equipment section (Section 5) of this procedure**.



NOTE: The Midtronics code from the tester must be recorded on the form.

Any actions must be carried out in accordance with the table shown in the **Determining Battery Condition section (Section 6) of this procedure**. The details must be recorded on the New Vehicle Storage Form which is part of the new vehicle storage document.

For additional information, refer to: [New Vehicle Storage Form](#) (100-11 Vehicle Transportation Aids and Vehicle Storage, Description and Operation).

4.4 REPLACEMENT BATTERIES FOR SERVICE

All service replacement batteries must have the battery condition checked within 24 hours of receipt and controlled on a 'First In First Out' basis to ensure batteries are not allowed to age unnecessarily.

For batteries in storage and not yet fitted to a vehicle, they must be stored in a dry environment, not in direct sunlight or under any direct heat source. Any batteries exhibiting any forms of damage or corrosion must not be fitted to any vehicle. Any batteries which are dropped must be scrapped, this applies even if no external damage is apparent.

The battery condition must be checked every 30 days in accordance with the battery test process utilizing a JLR approved tester as outlined in **the Equipment section (Section 5) of this procedure**.

Any actions must be carried out in accordance with the table shown in the **Determining Battery Condition section (Section 6) of this procedure**. The details must be recorded on the New Vehicle Storage Form which is part of the new vehicle storage document.

For additional information, refer to: [New Vehicle Storage Form](#) (100-11 Vehicle Transportation Aids and Vehicle Storage, Description and Operation).

4.5 BATTERY MAINTENANCE

Any battery whether it is in a vehicle or a replacement part must be tested and/or re-charged every 30 days and MUST be re-charged after every 90 day period.

4.6 BATTERY TEST PROCESS

It is recommended that this test is conducted at least 24 hours after the vehicle engine has been run or the battery charged to avoid the need of surface charge removal. If time constraints make this unacceptable then the surface charge must be removed.

Surface Charge Removal

A vehicle which has had its battery charged or been driven in a 24 hour period before the test, must have its surface charge removed.

- Turn on the ignition (power mode 6) but do not start the vehicle
- Switch on the headlamps on high beam for a minimum 3 minutes
- Switch off the headlamps
- Wait a minimum of 5 minutes before recording test results for any battery measurements

Battery Test

The battery may be tested either on a bench or on the vehicle.

The battery condition must be checked in accordance with the battery test process utilizing a JLR approved tester as outlined in **the Equipment section (Section 5) of this procedure**.



NOTE: The Midtronics code from the tester must be recorded on the form.

Any actions must be carried out in accordance with the table shown in the **Determining Battery Condition section (Section 6) of this procedure**. The details must be recorded on the New Vehicle Storage Form which is part of the new vehicle storage document.

For additional information, refer to: [New Vehicle Storage Form](#) (100-11 Vehicle Transportation Aids and Vehicle Storage, Description and Operation).



CAUTION: DO NOT connect the tester to any other circuit or chassis point other than the battery negative terminal.

5. EQUIPMENT

All equipment used must be functionally capable of meeting the compliance requirements. Please refer to the approved equipment document (JLR 000015).

In the case of batteries fitted to a new vehicle at the dealership, battery condition should be measured using the appropriate hand-held Midtronics tester as follows:

Battery Type	Battery Tester	Battery Tester
	Jaguar	Land Rover
AGM & Flooded	Midtronics EXP1080, GRX 3080	Midtronics EXP1080, GRX 3080

The test results must be recorded on the New Vehicle Storage Form which is part of the new vehicle storage document. For additional information, refer to: [New Vehicle Storage Form](#) (100-11 Vehicle Transportation Aids and Vehicle Storage, Description and Operation).



NOTE: All equipment must be calibrated

6 DETERMINING BATTERY CONDITION

TESTER RESULTS	ACTION
GOOD BATTERY	Return to service.
GOOD RE-CHARGE	Fully charge battery and return to service.
CHARGE AND RE-TEST	Fully charge battery. Remove surface charge. Re-test battery. If same result replace battery.
REPLACE BATTERY OR BAD CELL BATTERY	Verify surface charge removed. Disconnect battery from vehicle and re-test. If result repeats after surface charge removal, replace battery. DO NOT RECHARGE.
UNABLE TO DO TEST	Disconnect battery from vehicle and re-test.

7 BATTERY CHARGING

It is essential that a suitably ventilated defined area exists in each dealership / retailer for battery charging.



CAUTION: It is very important that when charging batteries using the traction charger or other stand-alone chargers that the charger is set for the correct type of battery before charging commences. If the wrong switch is selected the result would be a battery that is not charged fully and / or overheating can occur. Follow the manufacturers operating instructions.

Batteries **MUST BE** tested and if necessary charged every 30 days and charged after 90 days irrespective of any test. It is recommended that dealers / retailers always have fully charged batteries ready for use.



CAUTION: Do not charge AGM batteries with voltages over 14.8 Volts as this will damage the battery.

A designated controlled area must be allocated for scrap batteries and clearly controlled as such.

To bring a discharged but serviceable battery back to a fully charged condition proceed as follows:

- Check and if necessary top-up the battery electrolyte level. (Flooded maintainable batteries only)
- Charge the battery using a JLR approved charger as detailed in the approved equipment document following the manufacturers operating instructions.



NOTE: When using the Midtronics Diagnostic Charger, automatic mode must always be used. After charging and analysis, the charger may display 'Top-Off Charging', Hit STOP To End. Do not stop charging until the current falls to 5A or less, otherwise the battery will not be fully charged.

Following charging, a post charge battery condition test must be carried out in accordance with the table shown in the **Determining Battery Condition section (Section 6) of this procedure.**



NOTE: The Midtronics code from the tester must be recorded on the form.

Any actions must be carried out in accordance with the table shown in the **Determining Battery Condition section (Section 6) of this procedure.** The details must be recorded on the New Vehicle Storage Form which is part of the new vehicle storage document.

For additional information, refer to: [New Vehicle Storage Form](#) (100-11 Vehicle Transportation Aids and Vehicle Storage, Description and Operation).

8 BATTERY REPLACEMENT

If it is determined that a battery requires replacement, always refer to the appropriate section of the workshop manual for instructions on removing and installing the battery from the vehicle.

On in service vehicles fitted with a Battery Monitoring System (BMS), the BMS control module must be reset following the installation of a new battery. The BMS control module reset procedure must be performed using an approved diagnostic

system.

9 CONFIRMING ELECTROLYTE LEVEL

WARNINGS:



BEFORE CHECKING AND TOPPING-UP THE BATTERY ELECTROLYTE, REFER TO THE HEALTH AND SAFETY PRECAUTIONS SECTION.



AGM TECHNOLOGY BATTERIES ARE FULLY SEALED FOR LIFE AND NO ATTEMPT SHOULD BE MADE TO CHECK OR TOP UP THE ELECTROLYTE LEVEL.

On certain types of battery the electrolyte level may need to be checked.

- Make sure the battery is of a type suitable for topping up. These types of batteries will have cell plugs visible on the top face of the battery or a removable access panel to allow access to the cells.
- On batteries with a clear or opaque case and level marks, check the electrolyte level by visual inspection of the maximum level indicator mark on the battery casing indicating adequate level above the battery separators.
- On batteries with black cases, remove the cell plugs or access panel and ensure the electrolyte level is level with the indicator in the cell hole. A flashlight may be required to see the electrolyte level on this type of battery.
- If the electrolyte level is low, top-up using distilled water.



NOTE: Maintenance free and Valve Regulated (AGM) batteries are sealed and therefore cannot be topped up.



CAUTION: **DO NOT** overfill.

Battery and Charging System - General Information - Quiescent Drain

Description and Operation

VEHICLE QUIESCENT CURRENT TESTING

On vehicles fitted with a Battery Monitoring System (BMS), the diagnostic routine for quiescent drain testing in the approved Jaguar or Land Rover diagnostic system should be utilized.

If a customer complains of a vehicle battery that discharges continuously or when left for a prolonged period of time, it is recommended that a quiescent drain test is performed as described below.

The battery drain should be measured using the approved Jaguar or Land Rover diagnostic system or a Digital Multi-Meter (DVOM). A procedure for quiescent drain measurement using the diagnostic system is available in the Diagnosis and Testing section of the Workshop Manual. The vehicle should be in the locked/armed state (for example vehicle alarm fully armed), all doors, engine and luggage compartment lids are open and latched (so as to appear closed from an electrical point of view). The test should take place after the vehicle has entered shutdown mode. The time taken for this to occur after the ignition is switched off varies according to model (Refer to the Topix On line resource for details).

When the vehicle is armed, the effect of the security system Light Emitting Diode (LED) flashing is to cause a pulsation in the measured current drain. In this case, either the average current should be taken (using a Digital Multi-Meter (DVOM) with an averaging system) or the current reading taken, ignoring the brief high current peaks.

EQUIPMENT

Approved Jaguar or Land Rover diagnostic system with current probe **OR** Digital Multi-Meter (DVOM) with current probe.

METHOD OF MEASUREMENT

Using an Approved Jaguar or Land Rover Diagnostic System.

1. Switch off all electrical loads and ensure that the ignition is off
2. Connect the current probe to the approved Jaguar or Land Rover diagnostic system
3. Calibrate the probe
4. Install a clamp around the battery lead/junction box lead
5. Go to the Quiescent Current Testing section in this procedure

Using a digital multimeter

Do not use an in-line DVOM to measure the quiescent drain on vehicles fitted with an electronic throttle (for example XK 2006 onwards). The current exceeds the maximum amount the fuse in the DVOM is capable of handling.

1. Switch off all electrical loads and ensure that the ignition is off
2. Connect the current probe to the digital multimeter
3. Calibrate the probe
4. Install a clamp around the battery lead/junction box lead
5. Go to the Quiescent Current Testing section in this procedure

QUIESCENT CURRENT TESTING

1. Switch ignition to 'on' or select ignition mode in keyless vehicles and switch to 'off' (do not crank)
2. Remove key from ignition switch (if equipped)
3. Open and latch all doors, hood and luggage compartment lid
4. Lock the vehicle using the remote function on the remote handset. (Single lock only to avoid volumetric alarm arming)
5. Remove any other potential electrical drains such as accessories plugged into accessory sockets
6. Record the amperage readings after the shutdown period referenced in the Topix on line resource for details. Note all cars from 10MY onwards and XK from 07MY and XF from 08MY should be less than 30mA after 30 minutes
7. Record the final reading on the battery report form

The preferred method of testing following an excessive current consumption figure is to use a current probe around individual junction box leads to the various suspected circuits to identify a potential cause. This is in preference to the old method of removing fuses for the following reasons:

The drain may be caused by a module remaining active and preventing the quiescent drain from reducing to normal levels

The drain may be caused by a relay winding that is activated. Pulling the fuse can allow this to 'reset' and the drain will be lost and go un-diagnosed

QUIESCENT DRAIN - TYPICAL VALUES



NOTE: The quiescent drain after the initial shutdown period should not exceed the value shown in the table.

Jaguar Quiescent Drain Values

MODEL	SHUT DOWN PERIOD (minutes)	TYPICAL VALUES BATTERY DRAIN (mA)
XJS 3.2	60	<30
Sovereign 3.2	60	<37.3

MODEL	SHUT DOWN PERIOD (minutes)	TYPICAL VALUES BATTERY DRAIN (mA)
XJ6 4.0	60	<38.6
XJS	60	<43.9
XJ6 (X300) (1995MY)	60	<43
XJ8 (X300)	60	<30
XK8 (X100)	60	<30
S-Type (X200)	60	<30
X-Type (X400)	30	<30
XJ6 (X350)	40	<30
XJ8 (X350)	40	<30
XK (X150) - From 2006MY	<20 (after lock/arm condition) ²	<30
	33 (unlocked)	<30
XF (X250) - From 2008MY	<20 (after lock/arm condition) ²	<30
	33 (unlocked)	<30
XF (X250) - From 2013MY	<10 (after lock/arm condition) ²	<25
XF SportBrake (X250) - From 2013MY	<10 (after lock/arm condition) ²	<25
	<20 (unlocked)	<25
XJ (X351) - From 2010MY - 2012MY	10 (afterlock/arm condition) ²	<20
	30 (unlocked)	<20
XJ (X351) - From 2013MY	10 (afterlock/arm condition) ²	<20
	<20 (unlocked)	<20
F - Type (X152) - From 2013MY	10 (afterlock/arm condition) ²	<20
	<20 (unlocked)	<20



NOTE:

1. The total current drain will be higher if certain approved accessories are fitted (for example: tracker, trailer module, etc.)
2. Applies to vehicles without Tire Pressure Monitoring System (TPMS). Vehicle shut-down period with TPMS is approximately 15 minutes.

Battery and Charging System - General Information - Battery Report Form – In Service Batteries Only

Description and Operation



NOTE: Fields marked with * are mandatory and must be completed.

General Information								
*Vehicle Identification Number (VIN):				Vehicle Model:	Engine type:			
*Mileage:				*Repair Date:				
Customer Questions								
*1: What is the customer's reason for dealer visit? (tick symptoms as appropriate)				Non crank	Crank but non start	Warning message	Other:	
*2: How long was the vehicle left prior to issue.				*				
*3: How was the car left (Locked/unlocked)				*				
*4: How did you access to the vehicle				Key fob	Manual key	Handle pull		
*5: Has the vehicle required assistance for battery issues previously?				Yes		No		
*6: Is the vehicle used? (tick symptoms as appropriate)				Daily	Every other day	Weekly	Less than weekly	
*7: Average journey length				*				
*8: How many starts do you typically do in a day				*				
*9: Did the customer see any instrument pack warnings prior to the issue?				*				
*10: Have any of the features been used without the engine running in the last 3 days (if fitted?)		Radio	Power point accessory	CD	DVD	USB or IPOD connection	TV	Rear seat entertainment
11: Customer comments: - Please add any additional comments that are relevant.				*				
Diagnostics (Battery Testing)								
1: Loose battery clamps				Yes	*	No	*	
2: Loose hold down clamps				Yes	*	No	*	
3: Corroded terminal posts				Yes	*	No	*	
4: Physical damage/leaks				Yes	*	No	*	
5: Low electrolyte (Flooded batteries only)				Yes	*	No	*	
6: Battery Date Code				*				
7: FEAD belt tension				OK	*	Not OK	*	
8: Quiescent Drain				mA	*			
9: Vent tube correctly installed				Yes	*	No	*	
10: Number of Times Battery Charged:				*				
10: Vent tube correctly installed				Yes	*	No	*	
11: Remove the Surface (414-00 battery care requirements)				Yes	*	No	*	
12: Battery voltage				*				
13: Midtronics test code before charging (EXP-1080)				*				
13a: If Midtronics indicates that the battery needs re-charging, charge the battery following instructions on the recommended battery charger				*				
13b: Midtronics test code after charge				*				
13c: Midtronics test code result after charge				*				
13d: If "good and re-charge" charge the battery following instructions on the recommended battery charger				*				
13e: If "charge and re-test" for both before and after the charge renew the battery				*				
13f: Only renew the battery if "renew battery", "bad cell" or charge and re-test has been displayed twice.				*				
Technician Comments:- Please add any additional comments that are relevant.								
*								
*								
*								
*								
*								

Battery and Charging System - General Information - Charging System

Diagnosis and Testing

For additional information.

REFER to: Battery (414-01, Diagnosis and Testing).

Battery, Mounting and Cables -

Battery Specification

Engine Specification	Vehicle Specification			Rest of world
	Europe			
	Vehicles fitted without electrical optional extras	Vehicles fitted with electrical optional extras		
Vehicles fitted with 2.7L diesel engine	90 Ahr	90 Ahr	90 Ahr	
Vehicles fitted with 3.0L petrol engine	80 Ahr	90 Ahr	90 Ahr	
Vehicles fitted with 4.2L petrol engine	90 Ahr	90 Ahr	90 Ahr	

Battery cold cranking Specification

Item	Specification
90 Ahr	800 Amps
80 Ahr	700 Amps

Torque Specifications

Description	Nm	lb-ft	lb-in
Battery positive cable to rear junction box retaining nut	12	9	-
Battery monitoring system retaining nut to battery positive terminal	5	-	44
Battery ground cable to body retaining bolt	12	9	-
Battery tray	10	-	89
Battery cable terminal	6	-	53
Battery clamp bolt	8	-	71

Battery, Mounting and Cables - Battery and Cables - Component Location

Description and Operation

COMPONENT LOCATION - SINGLE BATTERY VEHICLES

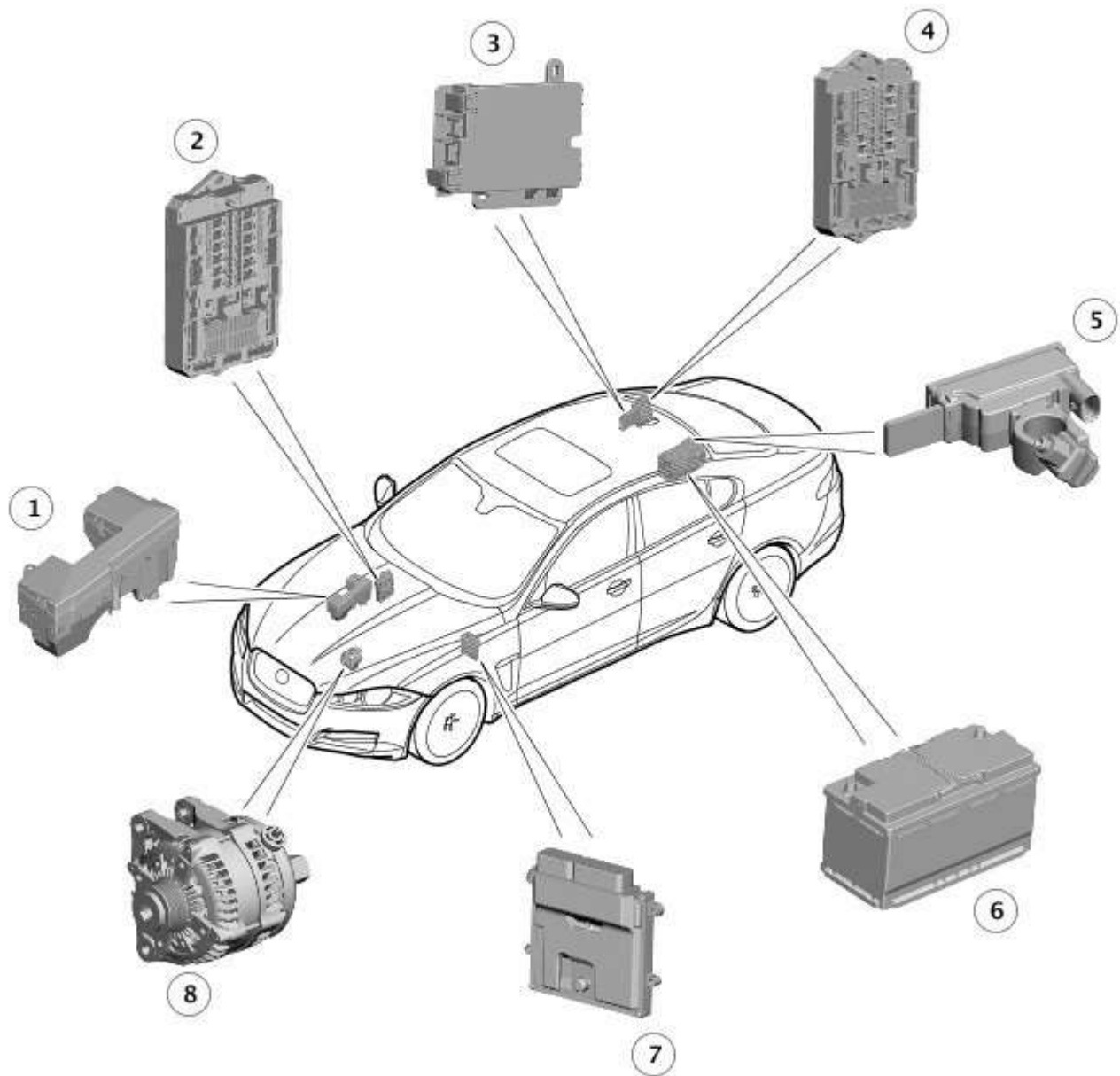

E167504

Item	Description
1	EJB (engine junction box)
2	CJB (central junction box)
3	BJB (battery junction box)
4	RJB (rear junction box)
5	BMS (battery monitoring system)
6	Battery
7	ECM (engine control module)
8	Generator

COMPONENT LOCATION - DUAL BATTERY VEHICLES

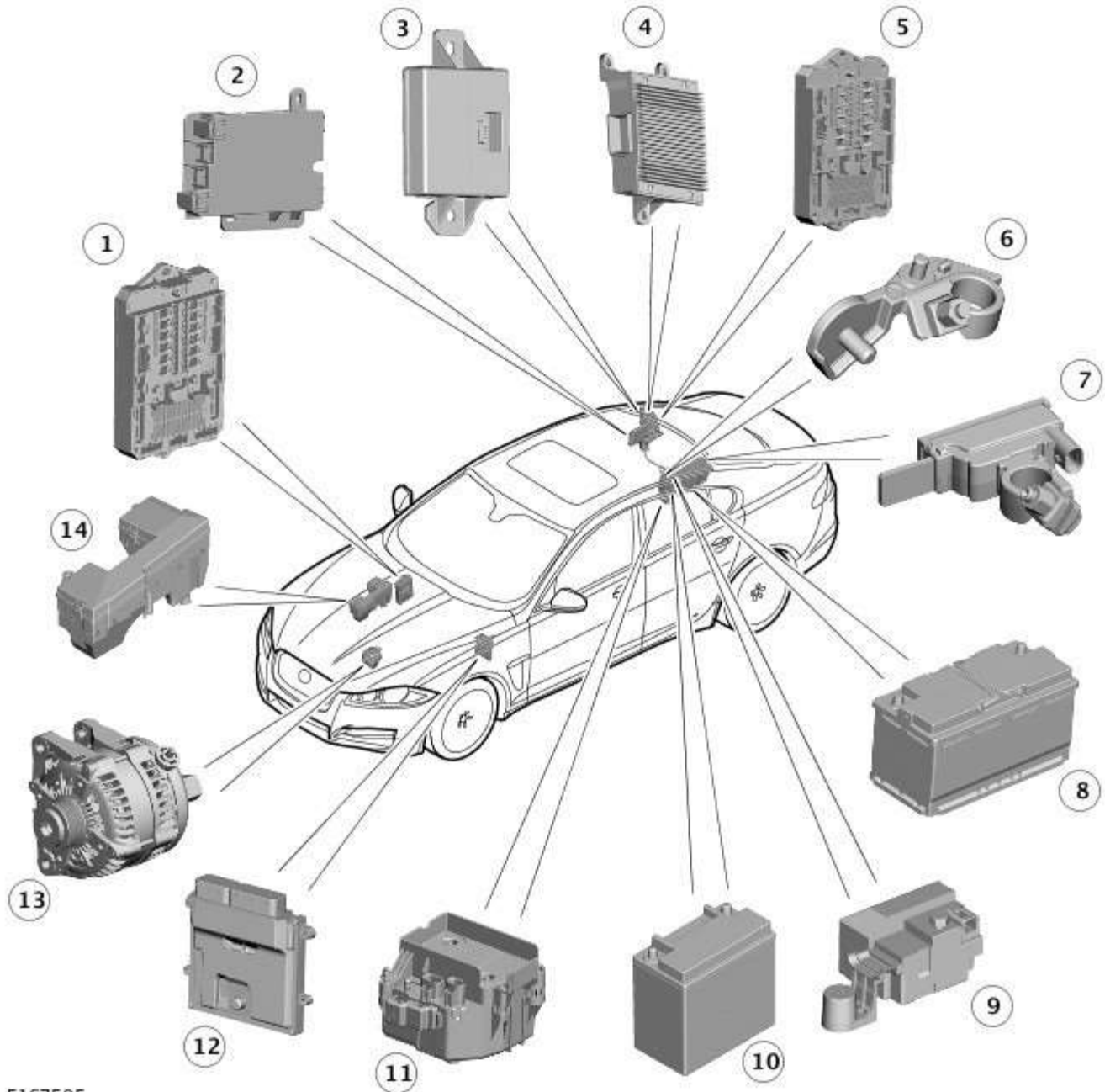

E167505

Item	Description
1	CJB Generator
2	BJB Starter motor
3	GWM (gateway module)
4	DBM (dual battery module)
5	RJB Duel battery module
6	Battery to BJB terminal
7	BMS (battery monitoring system) Duel battery fuse box
8	Primary battery
9	Transit relay
10	Secondary battery
11	DBJB (dual battery junction box)
12	ECM
13	Generator
14	EJB

Battery, Mounting and Cables - Battery and Cables - Overview

Description and Operation

OVERVIEW

Single Battery Vehicles

Mounted on the battery negative terminal is a BMS (battery monitoring system) module. The BMS module is integral with the battery negative cable and is controlled by the [ECM \(engine control module\)](#).



CAUTION: To avoid damaging the battery monitoring system module, always use a suitable body ground point rather than the battery negative terminal when connecting a slave power supply to the vehicle.

If a new battery is fitted to the vehicle, the BMS module will require re-calibrating using the Jaguar approved diagnostic system.

Fitted on the battery positive terminal is a transit relay. The transit relay must be removed from the vehicle during the Pre-Delivery Inspection (PDI). For additional information, refer to the PDI Manual.

The vehicle battery provides power to the [BJB \(battery junction box\)](#). The [BJB](#) contains 3 megafuses, delivering power to the [RJB \(rear junction box\)](#), the [CJB \(central junction box\)](#) and the [EJB \(engine junction box\)](#). In addition to containing fuses and relays, the [RJB](#) and [RJB](#) contain software to control a number of vehicle systems. These functions are covered in the appropriate sections of this manual.

Dual Battery System Vehicles - TD42.2L Engine Variants Only

Two batteries are fitted to accommodate the dual battery system used for the Stop/Start system.

A primary battery is located in the luggage compartment floor in a plastic molded tray and secured with a metal rod. The secondary battery is located in the [DBJB \(dual battery junction box\)](#).

- The primary battery is a 90Ahr, 850A CCA AGM Battery.
- The secondary battery is a 14Ahr, 200A CCA Absorbed Glass Mat (AGM) Battery.

A BMS (battery monitoring system) control module is mounted on the primary battery negative terminal. The BMS control module is integral with the battery negative cable and is controlled by the [GWM \(gateway module\)](#).



CAUTION: To avoid damaging the BMS control module, always use the ground (negative (-)) terminal stud point on the right side top mount. Never connect directly to the primary battery negative terminal when connecting a slave power supply to the vehicle, the BMS control module can be damaged.

If a new primary battery is fitted to the vehicle, the BMS control module will require re-calibrating using a Jaguar approved diagnostic system.

When the vehicle leaves the factory, a transit relay is fitted to the battery positive terminal. The transit relay is connected to the [CJB](#) which limits the electrical functions to essential items only, to reduce loads on the primary battery. The transit relay must be removed from the vehicle during the PDI (Pre-Delivery Inspection). For additional information, refer to the PDI.

The primary battery provides power to the [BJB](#). The [BJB](#) contains three megafuses, delivering power to the [RJB](#), the [EJB](#) and the starter motor and generator. In addition to containing fuses and relays, the [RJB](#) and [CJB](#) contain software to control a number of vehicle systems. These functions are covered in the appropriate sections of this manual.

A jump start terminal is located adjacent to the [EJB](#). A cover protects the terminal when not in use. If jump starting is required, the cover must be removed and the positive (+) jump lead attached securely. The negative (-) jump lead is attached to a stud located on the right side top mount in the engine compartment. The cover must be fitted to the positive terminal when not in use.

Dual Battery System

The dual battery system is used on vehicles with the stop/start system. The dual battery system prevents the vehicle electrical systems being subjected to undesirably low voltages during repeated engine restarts. If the electrical systems are subject to low voltages the customer may notice degraded performance of components and systems and incorrect fault [DTC \(diagnostic trouble code\)](#)'s may be stored.

The dual battery system isolates all electrical components and systems sensitive to low supply voltage from the primary battery while an engine start is in progress, and supplies them from the secondary battery. Without the dual battery system, the electrical power required by the TSS (Tandem Solenoid Starter) motor to crank the engine for each start would cause a voltage drop across the entire vehicle electrical network, and cause control modules to function incorrectly and in some cases reset and/or record DTC's.

If the dual battery system is unable to prevent electrical supplies to the vehicle systems being subjected to low voltage levels during engine stop/start operations, due to the condition of the primary and/or secondary batteries or a system fault, the stop/start feature is disabled.

The dual battery system comprises the following components:

- Dual Battery Module (DBM).
- Dual Battery Junction Box (DBJB).
- Gateway Module (GWM).
- Primary battery.
- Secondary battery.

The GWM hosts most of the software required to control the dual battery system and components. The GWM monitors the components and can store fault related DTC's.

The GWM also controls the charging system software in conjunction with the [ECM](#), RJB, CJB and [ABS \(anti-lock brake system\)](#) control module via the high speed and medium speed [CAN \(controller area network\)](#) bus. The GWM software will monitor the status of the stop/start system and determine when a stop/start event can occur. It can also intervene to maintain vehicle systems by keeping the engine running or initiating a restart due to, for example, climate control system requirements or request for restart from the ECM. A brake pressure signal is received from the ABS control module which will indicate to the GWM that an engine restart is required from driver operation of the foot brake.

The GWM contains the intelligent power management system and the BMS software. Monitoring of the primary battery condition for stop/start is controlled by the GWM and the BMS control module.

Battery, Mounting and Cables - Battery and Cables - System Operation and Component Description

Description and Operation

Control Diagram



NOTE: A = Hardwired, D = High speed CAN (Controller Area Network) bus, N = Medium speed CAN bus, O = LIN (Local Interconnect Network) bus.

CONTROL DIAGRAM - SINGLE BATTERY VEHICLES

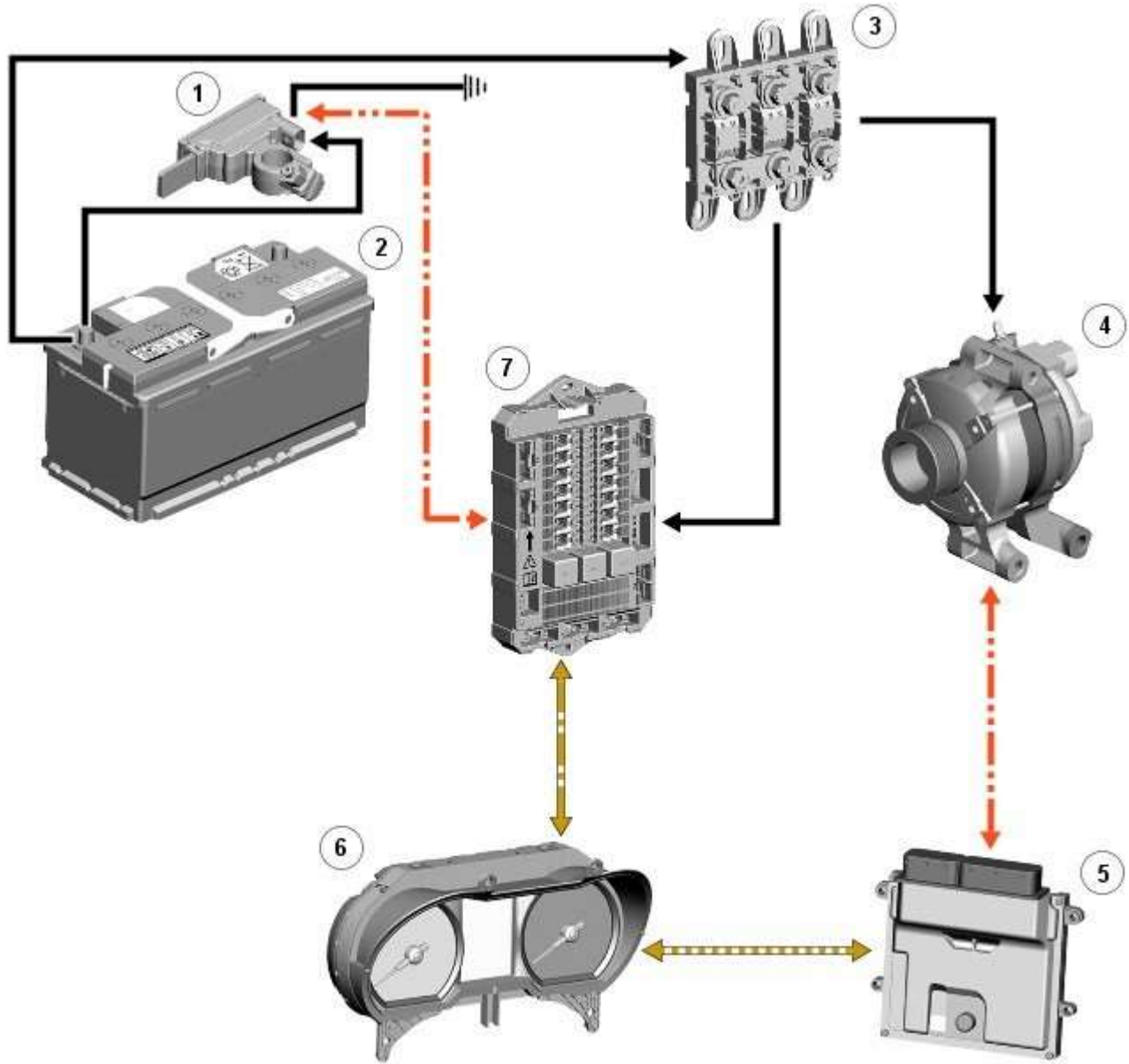

E96985



Item	Description
1	Battery Monitoring System (BMS) control module
2	Battery
3	Battery junction box (BJB)
4	Generator

5	ECM (engine control module)
6	Instrument Cluster
7	Rear Junction Box (RJB)

CONTROL DIAGRAM - DUAL BATTERY SYSTEM VEHICLES

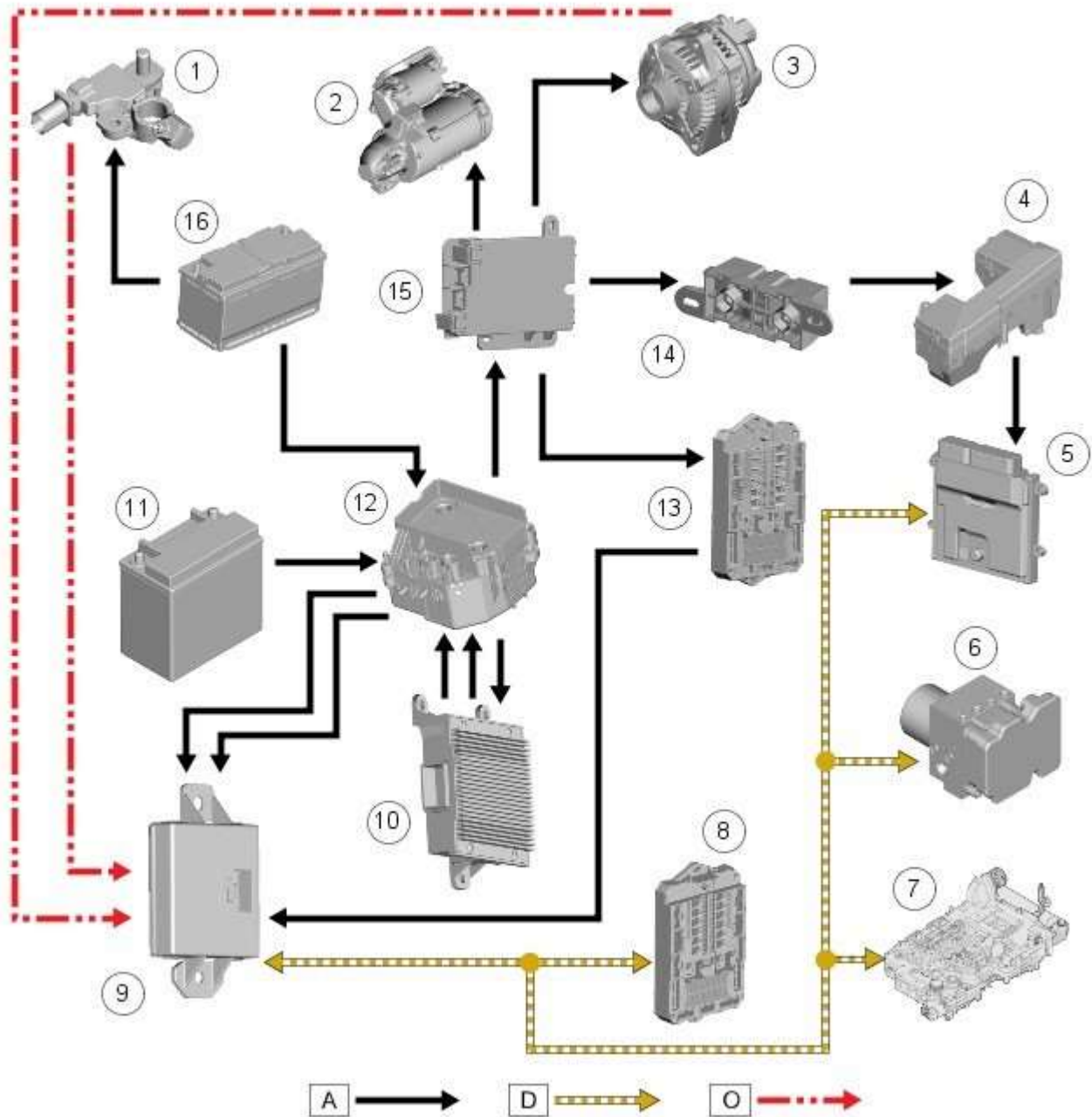

E152679

Item	Description
1	Battery Monitoring System (BMS) control module
2	Tandem Solenoid Starter (TSS) motor
3	Generator
4	Engine Junction Box (EJB)
5	Engine Control Module (ECM)
6	Anti-lock Brake System (ABS) control module
7	Transmission Control Module (TCM)
8	Central Junction Box (CJB)
9	Gateway Module (GWM)
10	Dual Battery Module (DBM)

11	Secondary battery
12	Dual Battery Junction Box (DBJB)
13	Rear Junction Box (RJB)
14	Megafuse
15	Battery Junction box (BJB)
16	Primary battery

System Operation

BATTERY MONITORING SYSTEM - TD4 2.2L DIESEL VEHICLES ONLY

Periodically the battery monitoring system module will instigate a self-calibration routine. To self calibrate, the battery monitoring system first charges the battery to its full condition.



NOTE: If the vehicle is only driven for short periods the charging process could take a number of days to complete.

Once the battery is fully charged, the battery monitoring system will discharge the battery to approximately 75% of its full state of charge, but never lower than 12.2 V. The time taken to complete this part of the routine is dependent on the electrical load on the vehicle.

When the second part of the routine has been successfully completed, the battery monitoring system will return the battery to its optimum level of charge. The optimum level of charge will be between 12.6 V and 15 V, depending on battery condition, temperature and loading.

The battery monitoring system module also monitors the battery condition with the engine switched off. If a low voltage condition is detected the module can request the infotainment system is switched off to protect battery voltage. Once the infotainment system has been switched off, the vehicle must be run for at least 5 minutes to charge the battery before the infotainment system can be operated with the engine switched off.

BATTERY MONITORING SYSTEM - SINGLE AND DUAL BATTERY SYSTEM VEHICLES

When the ignition is off (power mode 0), the BMS control module records the primary battery state of charge and begins to monitor the battery condition from this point.

If the battery state of charge falls by 7%, the BMS control module will monitor the primary battery for 5 minutes. If after the 5 minute monitoring period, the primary battery charge has continued to fall due to the quiescent drain current being too high, the BMS control module will determine that some control modules are still 'awake'. The BMS control module sends a shutdown message on the LIN (local interconnect network) bus to the GWM (Gateway Module). The GWM sends a CAN (controller area network) bus message on both the medium and high speed networks to all control modules, requesting them to shutdown.

The BMS control module will monitor the primary battery state of charge for a further 5 minutes and determine if the primary battery state of charge is still dropping. If a quiescent drain current continues, the primary battery state of charge will continue to drop. If the state of charge falls to 12% of the initial monitoring value, the BMS control module determines that one or more control modules are still awake and a failure to respond to the shutdown request may indicate an error state within the control module(s).

BMS Low Battery Warning and Energy Management Messages

The BMS continuously monitors the condition of the primary vehicle battery. If excessive battery discharge occurs, the system will begin to shut down non-essential electrical systems in order to protect the battery.

If the BMS calculates that battery condition is not within set parameters, there are 3 messages that can be displayed, 2 on the touch screen and 1 on the message center. These inform the user that the battery is either at a low level of charge or the engine-off power consumption limit has been exceeded.

- **Low Battery - Please switch engine on or system will shutdown in 3 minutes:** is displayed as a **Warning** on the touch screen if the engine is not running. This indicates that the battery has fallen below a predefined threshold. As soon as the battery is charged back above this threshold then the message will be removed.
- **Low Battery - Please start your engine** is displayed on the message center if the engine is not running. This indicates that the battery has fallen below a predefined threshold. As soon as the battery is charged back above this threshold then the message will be removed or it can be manually removed by pressing 'OK'.
- **System will shut down in 3 minutes:** is displayed as an **Energy management** on the touch screen if the engine is not running, and system features are causing excessive battery discharge. After 3 minutes the BMS will begin shutting down vehicle systems. Normal system operation will resume when the engine is started.

This is based on a percentage of battery capacity available for the customer to use with the engine off. The percentage can change based upon several factors.

Once triggered, the resetting of this message will not occur until the vehicle is driven for 10 minutes with the engine running (to allow the battery to recoup any lost charge). However, if the engine is run for less than 10 minutes, the message will only be displayed after an additional 5 minutes with the ignition on but engine off.

BMS Control Module Self Calibration

Periodically the BMS control module will instigate a self-calibration routine. To self calibrate, the battery monitoring system

first charges the battery to its full condition.



NOTE: If the vehicle is only driven for short periods the charging process could take a number of days to complete.

Once the battery is fully charged, the BMS control module will discharge the battery to approximately 75% of its full state of charge, but never lower than 12.2 V. The time taken to complete this part of the routine is dependent on the electrical load on the vehicle.

When the second part of the routine has been successfully completed, the BMS control module will return the battery to its optimum level of charge. The optimum level of charge will be between 12.6 V and 15 V, depending on battery condition, temperature and loading.

The BMS control module also monitors the primary battery condition with the engine switched off. If a low voltage condition is detected the BMS control module can request the infotainment system is switched off to protect battery voltage.

DUAL BATTERY SYSTEM - DUAL BATTERY SYSTEM VEHICLES ONLY

The dual battery system prevents electrical loads on the vehicle being subjected to low voltage levels during an ECO (stop/start system) engine start. Low voltage can occur due to the power demand of the TSS (Tandem Solenoid Starter) motor and could result in degraded performance of components and/or system control modules. The GWM contains the software to control the dual battery system and electrical load management system to ensure that ECO engine starts do not affect other vehicle systems.

The dual battery system isolates all power supply sensitive electrical components which may be affected by low voltage from the primary battery due TSS motor operation, and supplies them with power from the secondary battery when an engine start is in progress.

The DBJB (Dual Battery Junction Box) contains two contactors, which operate to change the power supply into two separate circuits when an ECO engine start is required. Sensitive electrical components are supplied from the secondary battery. The primary battery power is used exclusively to supply the TSS motor and maintain essential power loads to the engine management system required for engine starting. The contactors are operated by the DBM (Dual Battery Module) on receipt of LIN bus information from the GWM.

Dual Battery System - Normal State (Engine Running)

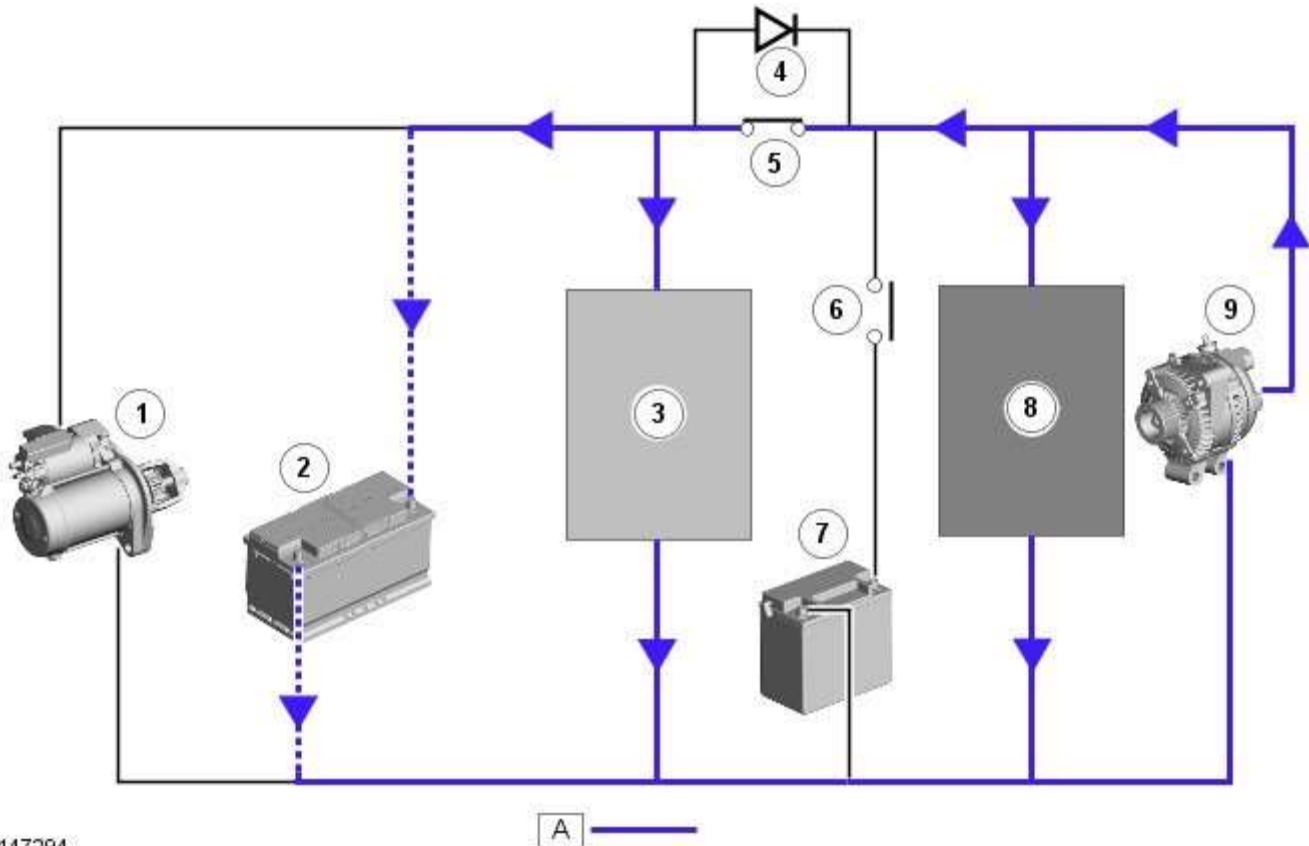

E 147294

A ———

Item	Description
1	Tandem Solenoid Starter (TSS) motor
2	Primary battery
3	Power and engine management system loads

4	Field Effect Transistor (FET)
5	Contactor 1 - closed
6	Contactor 2 - open
7	Secondary battery
8	Sensitive loads
9	Generator



NOTE: A = Primary battery supply

When the engine is running, the electrical systems are powered from the primary battery and the generator. The GWM and the DBM communicate via the LIN bus and the DBM controls the DBJB contactors to isolate the secondary battery from the system by opening its contactor.

The GWM monitors the state of charge of both the primary and secondary batteries to ensure that sufficient voltage is available for the next ECO engine start. The GWM can apply charging to the secondary battery via the DBM and the DBJB if required.

Dual Battery system - ECO Engine Stop/Start State

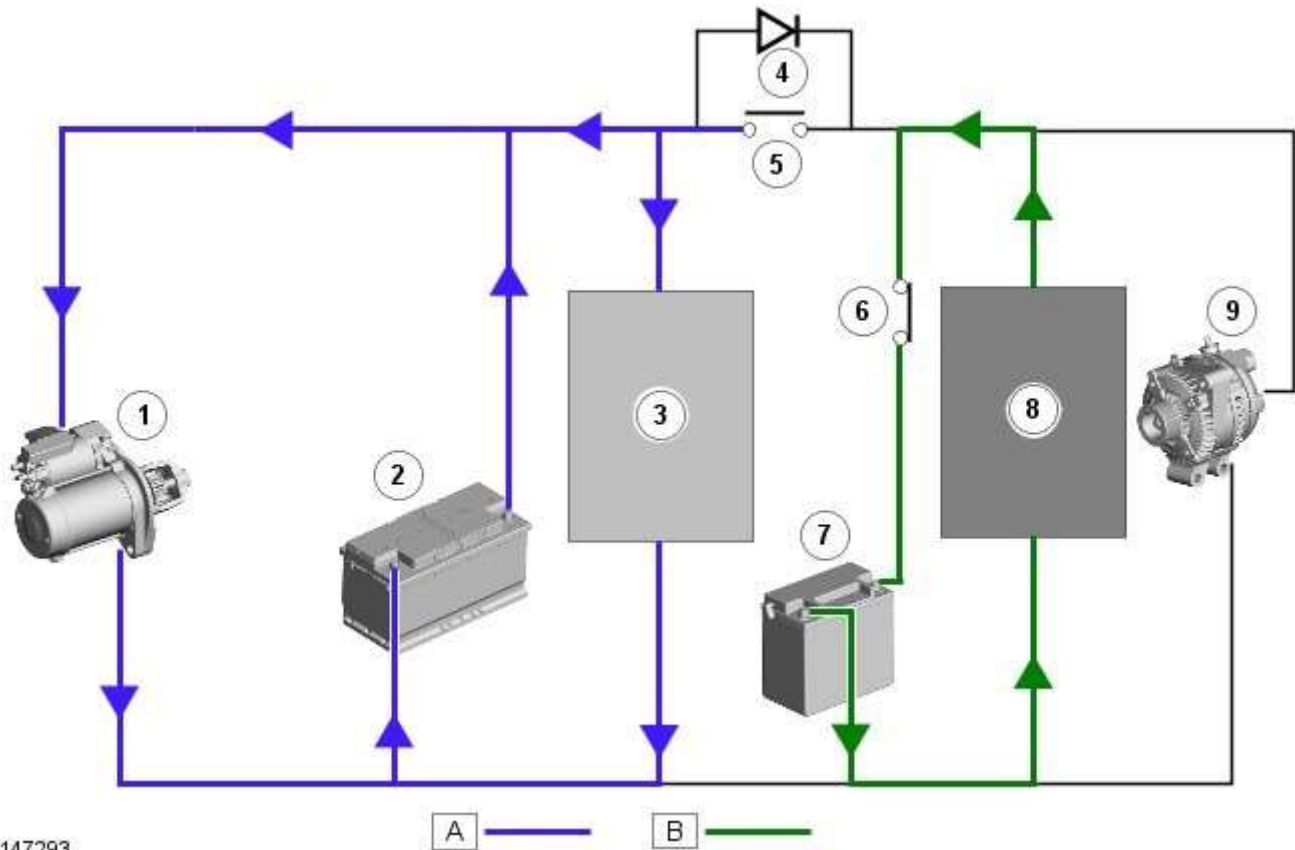

E 147293

Item	Description
1	Tandem Solenoid Starter (TSS) motor
2	Primary battery
3	Power and engine management system loads
4	Field Effect Transistor (FET)
5	Contactor 1 - open
6	Contactor 2 - closed
7	Secondary battery
8	Sensitive loads
9	Generator



NOTE: A = Primary battery supply, B = Secondary battery supply

When an ECO engine start is required, the DBJB must change the battery supply via the two contactors before the TSS motor

is operated to crank the engine. The GWM is connected to the ABS (Anti-lock Brake System) control module via the high speed CAN bus. With the vehicle stationary and the engine off after an ECO engine stop, when the driver releases the brake pedal the ABS control module senses the reduction in brake pressure. This change of brake pressure state is sent as a high speed CAN message which is received by the GWM and the ECM. The GWM reacts within 105ms to instruct the DBM via the LIN bus to operate the two contactors in the DBJB to supply the sensitive loads from the secondary battery and supply the TSS motor direct from the primary battery.

When the engine is running and the generator is supplying power to the vehicle systems, the GWM again instructs the DBM to operate the two contactors in the DBJB to supply all vehicle systems from the primary battery and the generator and to isolate the secondary battery.

Secondary Battery Charging

The DBM also controls the charging of the secondary battery. The GWM contains electrical load management software and monitors both batteries for their state of charge. The primary battery is monitored by the BMS control module which is connected to the DBM via the LIN bus. The DBM communicates the primary battery condition to the GWM via a LIN bus connection. The GWM sends a signal to the DBM via the LIN bus to instruct it to apply charging from the generator to the secondary battery when required. The contactor 2 is closed by the DBJB to complete the secondary battery circuit, and the generator output is applied to the secondary battery to charge it.

The generator output is controlled by the GWM which monitors and controls the electrical load management system. The generator is connected to the GWM by a LIN bus allowing the GWM to control the output of the generator to maintain electrical system load requirements and battery charging.

Electrical Load Management

The electrical load management is controlled by the GWM and the BMS control module.

The GWM will monitor the vehicle system power loads before and during an ECO engine stop.

Before an ECO engine stop, the GWM will transmit a signal to system control modules on the CAN bus to request a power save on all electrical loads and set a minimum electrical value override. The GWM monitors the vehicle electrical loads and will inhibit a ECO engine stop until the load current is at a value low enough to be supported by the secondary battery.

If the electrical loads cannot be reduced sufficiently, the GWM will inhibit the ECO engine stop.

When the engine is stopped after an ECO engine stop, the GWM will continue to monitor the primary battery state of charge. If the primary or secondary battery voltage falls below 11.0V, a level which will result in degraded starting performance or possible primary battery damage, the GWM will initiate an engine start.

System Inhibits

The ECO stop/start system is inhibited if the dual battery system is not be capable of preventing electrical loads on the vehicle being subject to unacceptably low voltage levels during ECO stop/start operations due to a fault.

ECO stop/start inhibit monitoring of the primary battery is performed by the BMS control module. If the primary battery voltage is too low to support an ECO stop/start, then the BMS control module will send a message to the GWM on the LIN bus to suspend ECO stop/start.

The GWM monitors the secondary battery and the dual battery system components. Any fault found will cause the GWM to inhibit ECO stop/start and the GWM will record a DTC (diagnostic trouble code).

Fault Diagnosis

The GWM performs passive and active diagnostics on the dual battery system to determine the status of the system components.

Passive diagnostics can detect faults in the DBJB and can check for stuck open or closed contactors and failure of DBM contactor command signals.

Active diagnostics is a routine to test the capability of the contactors to respond to open or close command signals sent from the GWM to the DBM. This routine also checks the FET's (Field Effect Transistors) activate as required. (Refer to Dual Battery Junction Box below for description of FET operation)

The GWM will also check the dual battery system components for faults in a controlled environment when the generator is providing a charging output. This will ensure that the detection of a fault will not result in sensitive electrical loads being subjected to low voltage which may occur during an ECO stop/start with a fault present.

The GWM will illuminate the charge warning indicator in the instrument cluster if fault is detected in the dual battery system which will result in a degraded power supply.

If a fault is detected the GWM transmits a CAN message to inhibit ECO stop/start operation. In some cases it will record a DTC, display a warning message in instrument cluster and also illuminate charge warning indicator.

Component Description

PRIMARY BATTERY - ALL VEHICLES

The primary battery is located in a plastic tray under the luggage compartment floor in the right side of the luggage compartment, adjacent to the spare wheel. The battery is vented via a tube which is connected with a T piece to the vent from

the secondary battery (if fitted) and passes through a grommet in the floorpan.

On new vehicles the primary battery positive terminal is fitted with a transit relay. The transit relay must be removed using the correct process detailed in the Pre Delivery Inspection (PDI) manual.

The battery negative terminal is fitted with a BMS control module. The control module is integral with the battery negative cable and communicates with the GWM via a LIN bus connection. The battery condition information is passed to the GWM which controls the generator output accordingly.



CAUTION: To avoid damage to the BMS control module, always use the body ground point in the engine compartment and not the battery negative terminal when connecting a slave power supply.

Failure to use the recommended ground point will lead to the setting of a DTC. Incorrect information of battery condition will be retained by the BMS control module due to the unmonitored current flow into the battery. The system will however, recognize and compensate for the change in battery status after a period of time.

If a new battery is fitted, the BMS control module will require re-calibration using a Jaguar approved diagnostic system. Replacement of the BMS control module requires no action as the control module will re-calibrate automatically.

SECONDARY BATTERY - DUAL BATTERY VEHICLES ONLY

The secondary battery is located in a tray on the next of the primary battery and is secured to the DBJB with a bracket. The battery negative (-) terminal is connected via a cable to the vehicle body. The positive (+) terminal is connected by a cable to the DBJB. The battery is vented via a tube which is connected with a T piece to the vent from the primary battery and passes through a grommet in the floorpan.

The state of charge of the secondary battery is monitored by the Gateway Module (GWM).

BATTERY MONITORING SYSTEM (BMS)

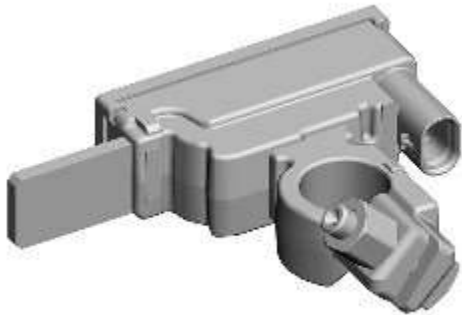

E167509

The BMS (battery monitoring system) control module is located on the primary battery negative (-) terminal. The module is located on the battery post and is clamped to the post with a bolt and nut.

The primary battery negative ground cable is connected to the BMS control module and is attached to a ground stud on the vehicle body.

The BMS control module is connected into the vehicle wiring harness via a multiplug. The BMS control module receives a 12V power supply direct from the primary battery positive terminal. A LIN (local interconnect network) bus connection provides communication between the BMS control module and the [ECM](#) for control and monitoring of the primary battery current drain and state of charge.

The BMS control module measures battery current and voltage, which it communicates to [ECM](#).



CAUTION: Due to the self-calibration routine, it is recommended that all power supply diagnostic testing is carried out using the Jaguar approved diagnostic system rather than a digital multimeter.

The BMS control module is able to generate DTC (diagnostic trouble code)'s to help diagnose primary battery or generator power supply issues. These DTC's can be read using the Jaguar approved diagnostic system. The Jaguar approved diagnostic system can also be used to implement a primary battery and generator self test routine. For additional information, refer to the Diagnosis and Testing section of the workshop manual.

If a fault is detected, the GWM (gateway module) will override the BMS control module.

The BMS control module DTC's can be used to help diagnose battery or generator power supply faults. The DTC's are stored in GWM. The Jaguar approved diagnostic system has a process for an automated power supply diagnostic procedure. The procedure provides a menu driven process to locate a fault in a logical sequence. The procedure uses the capability of the BMS control module and generator LIN bus controlled functions to provide current flow information and will detect if the BMS control module or generator are functioning correctly.

GATEWAY MODULE (GWM)



E147297

The GWM (gateway module) is located at the rear of the right wheel arch in the luggage compartment, adjacent to the DBM (dual battery module). The GWM is attached to a bracket, which is attached to a second bracket secured to the vehicle body.

The GWM contains software to control the following functions:

- Determine condition of primary and secondary batteries
- Control the output from the generator using load management software
- Controls ECO stop/start using power management to inhibit unnecessary electrical loads
- Control the DBJB (dual battery junction box) via the DBM to enable the switching of the contactors.

The GWM communicates with other system modules on the high speed and medium speed [CAN \(controller area network\)](#) buses.

The GWM communicates with the BMS (battery monitoring system) control module and the DBM via a [LIN](#) bus.

DUAL BATTERY MODULE (DBM)



E147298

The DBM (dual battery module) is located at the rear of the right wheel arch in the luggage compartment, adjacent to the GWM (gateway module) and the [RJB \(rear junction box\)](#). The DBM is attached to a bracket, which is attached to a second bracket secured to the vehicle body.

The DBM is connected by two hardwired connections to the DBJB (dual battery junction box). The DBM uses these two connections to apply battery voltage to the contactor coils in the DBJB. A [LIN](#) bus connection from the GWM passes contactor operation signals to the DBM which operates the contactors as applicable.

The GWM will also instruct the DBM to apply charging to the secondary battery via a LIN bus message. The GWM instructs the DBM of the charging current required for the secondary battery and the DBM applies the requested stabilized current to the secondary battery via a dedicated connection direct to the secondary battery.

The DBM diagnoses the coils of the contactors and will report a fault via the LIN bus to the GWM.

The DBM receives a fused power supply from the RJB.

DUAL BATTERY JUNCTION BOX (DBJB)

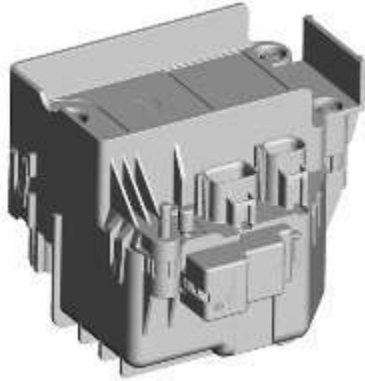

E147299

The DBJB (dual battery junction box) is located adjacent to the primary battery. The DBJB houses two contactors which are controlled by the DBM (dual battery module) and the GWM (gateway module) for switching power supplies during ECO stop/starts and also for charging the secondary battery.

FET's (field effect transistor's) are also located in the DBJB. The FET's are connected in parallel with contactor 1 and allow the primary battery power to flow to the sensitive loads during the contactor switching process to ensure there is no interruption in power supply to the sensitive loads. The FET's also act as a secondary path to allow power to be supplied to the sensitive loads should a fault occur and the contactor 1 becomes stuck open. The FET's will allow a current of up to 200A to flow through them.

The DBJB receives a battery supply direct from the primary battery to contactor 1 and a battery supply from the secondary battery to contactor 2. Two connections from the DBM are used for contactor coil control. A third connection from the DBM applies a stabilized voltage to the secondary battery for charging when requested by the GWM.

Battery, Mounting and Cables - Battery

Diagnosis and Testing

Principles of Operation

For a detailed description of the battery system and operation, refer to the relevant Description and Operation section of the workshop manual. REFER to: [Battery and Cables](#) (414-01 Battery, Mounting and Cables, Description and Operation).

Inspection and Verification



CAUTION: Diagnosis by substitution from a donor vehicle is **NOT** acceptable. Substitution of control modules does not guarantee confirmation of a fault and may also cause additional faults in the vehicle being checked and/or the donor vehicle.

NOTES:



Generic scan tools may not read the codes listed, or may read only five digit codes. Match the five digits from the scan tool to the first five digits of the seven digit code listed to identify the fault (the last two digits give additional information read by the manufacturer-approved diagnostic system).



When performing electrical voltage or resistance tests, always use a digital multimeter (DMM) accurate to three decimal places, and with an up-to-date calibration certificate. When testing resistance, always take the resistance of the DMM leads into account.



Check and rectify basic faults before beginning diagnostic routines involving pinpoint tests.



If DTCs are recorded and, after performing the pinpoint tests, a fault is not present, an intermittent concern may be the cause. Always check for loose connections and corroded terminals.

1. Verify the customer concern.
2. Visually inspect for obvious signs of mechanical or electrical damage.

Visual Inspection

Mechanical	Electrical
<ul style="list-style-type: none"> • Generator • Drive belt • Drive belt tensioner • Generator pulley • Check the security of the generator fixings 	<ul style="list-style-type: none"> • Generator • Battery • Battery connections • Starter motor • Harnesses and connectors • Fuses • Charge warning lamp function • Engine Control Module (ECM)

3. If an obvious cause for an observed or reported concern is found, correct the cause (if possible) before proceeding to the next step.
4. If the cause is not visually evident check for Diagnostic Trouble Codes (DTCs) and refer to the DTC Index.
5. Check DDW for open campaigns. Refer to the corresponding bulletins and SSMs which may be valid for the specific customer complaint and carry out the recommendations as required

Symptom Chart

Symptom	Possible Causes	Action
<ul style="list-style-type: none"> • Battery power to vehicle interrupted 	<ul style="list-style-type: none"> • High resistance between battery terminals and clamps 	<ul style="list-style-type: none"> • GO to Pinpoint Test A.



Midtronics EXP-1080 User Guide

Carry out the following: -

Surface Voltage Removal Process

A vehicle which has had its battery charged or been driven in a **24** hour period before the test, must have its surface charge removed

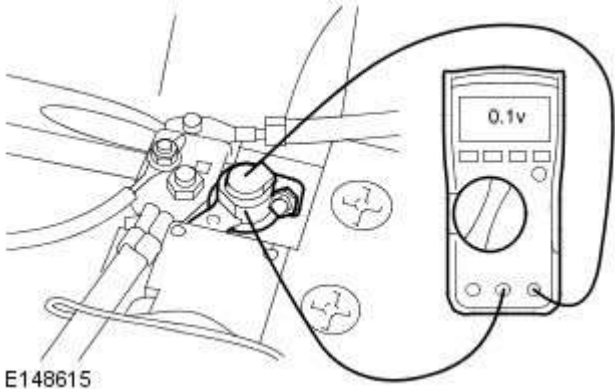
- 1. Turn on the ignition but do not start the vehicle
- 2. Switch on the headlamps on high beam for a minimum 3 minutes
- 3. Switch off the headlamps
- 4. Wait a minimum of 5 minutes before recording test results for any battery measurements

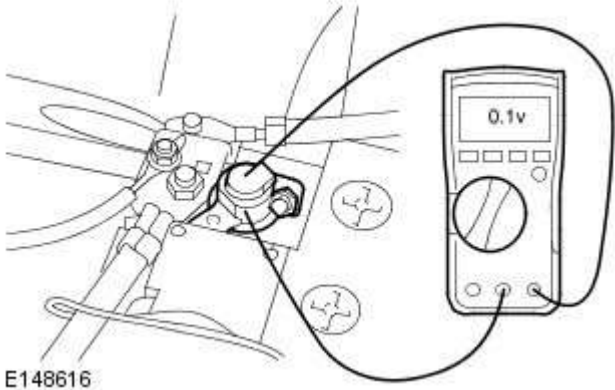
PINPOINT TEST A : VOLTAGE DROP	
TEST CONDITIONS	DETAILS/RESULTS/ACTIONS
A1: GROUND CIRCUIT	
 NOTE: This test checks for high resistance between the battery terminal and the battery clamp	
 E148615	1 Start the engine, turn on the following: <ul style="list-style-type: none"> • (1) Air conditioning • (2) Blower fan on full speed • (3) Headlights on main beam • (4) Heated screen - rear • (5) Heated screen - front (if installed) • (6) Heated seats (if installed)
	2 Connect the multimeter between the battery negative terminal and the battery clamp as shown in picture below (do not disconnect the battery at this stage)
	3 Set the multimeter to read DC voltage and record the reading Is reading equal to or below 0.1 volts? Yes GO to A2. No Switch all electrical loads and engine off, return the vehicle to an ignition off condition. Disconnect the battery negative clamp, clean clamp and terminal then reconnect and repeat test GO to A1.
A2: POWER CIRCUIT	
 NOTE: This test checks for high resistance between the battery terminal and the battery clamp	
 E148616	1 Start the engine, turn on the following: <ul style="list-style-type: none"> • (1) Air conditioning • (2) Blower fan on full speed • (3) Headlights on main beam • (4) Heated screen - rear • (5) Heated screen - front (if installed) • (6) Heated seats (if installed)
	2 Connect the multimeter between the battery positive terminal and the battery clamp as shown in picture below (do not disconnect the battery at this stage)
	3 Set the multimeter to read DC voltage and record the reading Is reading equal to or below 0.1 volts? Yes Carry out midtronics battery test procedure No Switch all electrical loads and engine off, return the vehicle to an ignition off condition. Disconnect the battery power clamp,

clean clamp and terminal then reconnect and repeat test [GO to A2](#)

Reference	Description
1	LCD screen with main menu
2	Control panel (key board and power button)
3	Positive and negative fly leads
4	Fly leads connection
5	Temperature sensor
6	Infra-red sensor (data transfer for printer)
7	Amp hour
8	Battery rating (CCA)
9	Rating units
10	Battery type

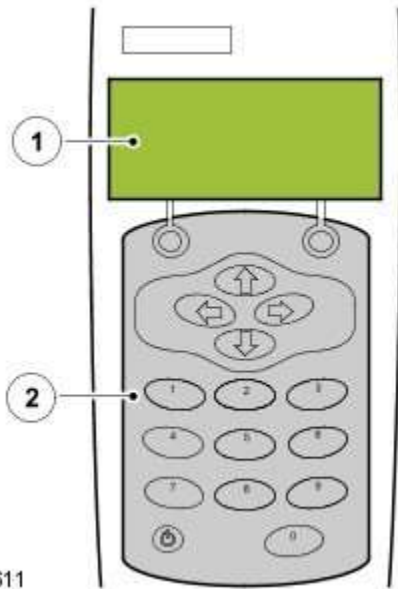

E148611

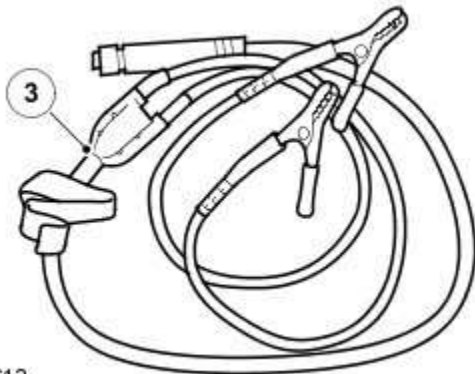

E148612

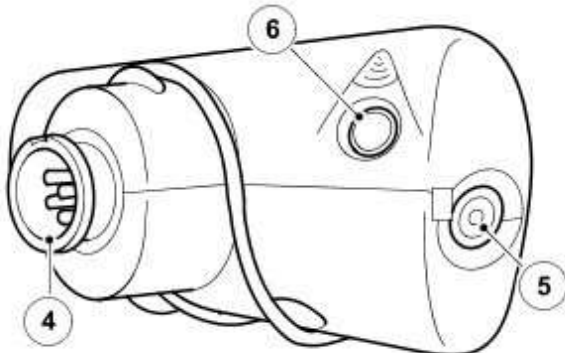

E148613

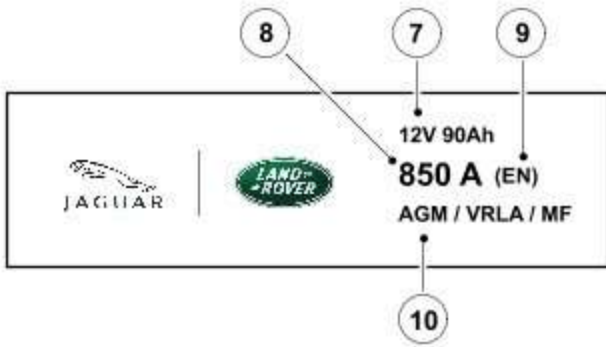

E148614



NOTE: Flooded batteries does not have AGM on the label

The following steps must be carried out to ensure correct operation of the EXP-1080 during the battery test procedure

Checks	Action
Battery fluid leakage, check for battery fluid leaks or damage to the battery casing	NOTE: If visible damage to the case is evident do not return battery under warranty Replace the battery if there is any battery fluid leaks evident
Battery vent pipe routing	Check for routing, ensure there are no kinks
EXP-1080 fly lead, condition of clamps	Clean or replace as required
EXP-1080 fly lead connection	Confirm secure connection



NOTE: The Midtronics EXP-1080 is suitable for testing flooded and absorbed glass mat (AGM) type batteries including Primary and Secondary batteries

Midtronics Battery Test Procedure

This midtronics battery test procedure will confirm the serviceability of the battery

- 1. Connect the fly-lead to the midtronics EXP-1080
- 2. Connect the fly-leads to the battery terminals
 - **Black lead to negative terminal**
 - **Red lead to positive terminal**
 - Confirm the connections are secure
- 3. The EXP-1080 will power on automatically when connected to a battery, screen below is displayed

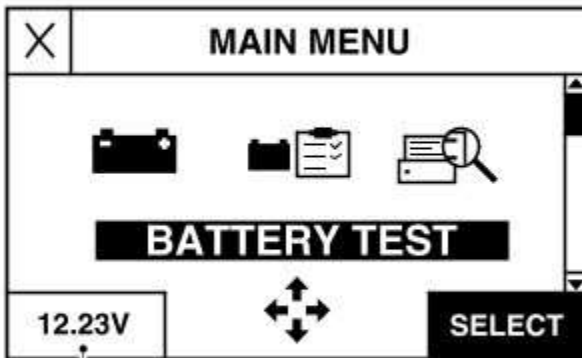

11

E164365



NOTE: MAIN MENU SCREEN

- 4. **Main Menu.** Select **Battery test** and press **SELECT**

X	BATT. LOCATION	
1	<input checked="" type="radio"/> IN VEHICLE	
2	<input type="radio"/> OUT OF VEHICLE	
BACK	↑↓	NEXT

E164366



NOTE: BATTERY LOCATION

- 5. **Battery Location**
- Select **Next**
- 6. **VIN**. When **IN VEHICLE** selected, enter the last six of the **VIN** using the key pad

X	VIN	
ENTER LAST 6 DIGITS OF VIN		
<input type="text"/>		
BACK	←→	NEXT

E164367



NOTE: BATTERY RATING

- 7. **Battery Type.** Select the correct battery type (Regular or AGM)



NOTE: ALL AGM batteries are marked (Refer to battery label) Flooded batteries have no reference to being Flooded.

- Select **Next**

X	BATTERY TYPE	
1	<input checked="" type="radio"/>	REGULAR/ FLOODED
2	<input type="radio"/>	AGM
BACK  NEXT		

E164368

X	RATING UNITS				
1	<input checked="" type="radio"/>	SAE	4	<input type="radio"/>	JIS
2	<input type="radio"/>	EN			
3	<input type="radio"/>	DIN			
BACK  NEXT					

E164369



NOTE: BATTERY TYPE

- 8. **Battery Units**. Select the correct battery rating from the battery label in brackets (number 9). Scroll using the arrow on the Midtronics panel and select **Next**



NOTE: UNITS

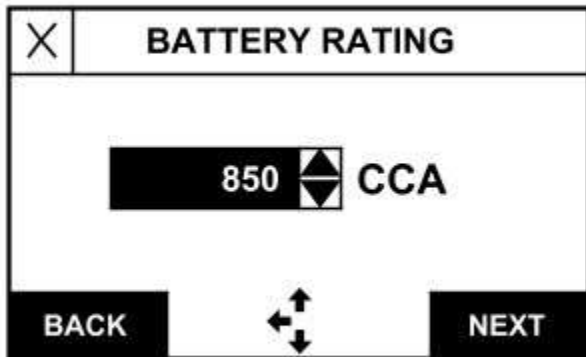

E164370



NOTE: BATTERY RATING

- 9. **BATTERY RATING**. Scroll using the arrow keys on the midtronics panel, select the correct **CCA** rating (For CCA refer to battery label)
- Select **Next**

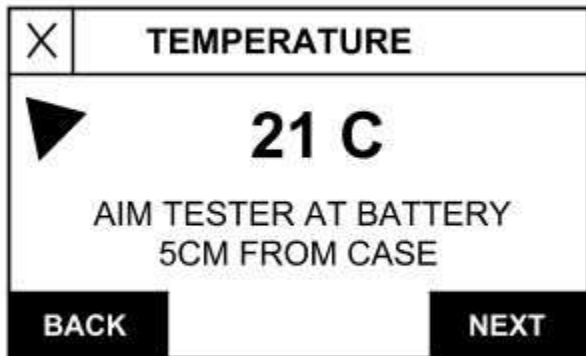

E164371

NOTES:

 TEMPERATURE

 Ensure that the temperature sensor does not touch any part of the battery or vehicle, this will cause damage not be covered under the midtronics warranty and will require the unit to be returned to a service center

- 10. **Temperature.** Aim the temperature sensor towards the battery casing (Maintain distance of 5cm)
- Select **Next**

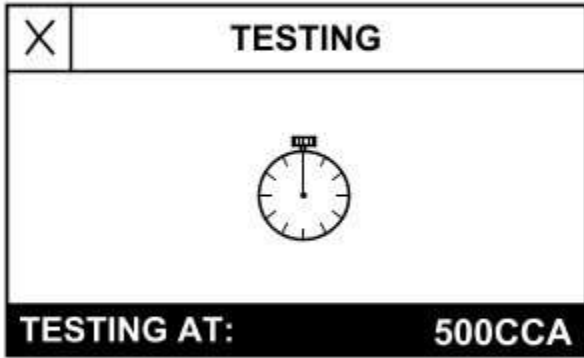

E164372

 NOTE: TESTING

- 11. **Testing.** The screen displays clock hand's rotating, the EXP-1080 will automatically advance when test has completed

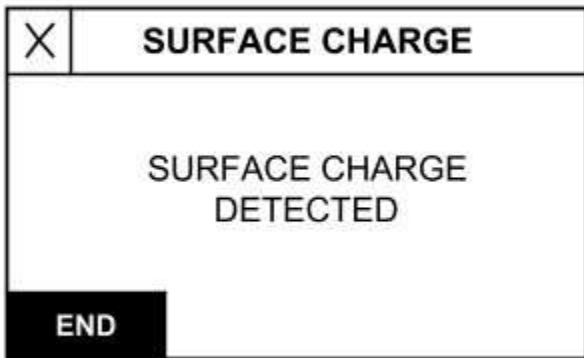

E164373

NOTES:

 SURFACE CHARGE

 If there is no surface charge this step will not show. **Go to next step**

- 11a. **Surface Charge.** This next step is an additional surface charge test required if the voltage is above 12.4v with a low CCA measured. Ensure the **ignition state is on**. Switch on the headlights (high beam) until EXP-1080 shows **Turn off headlights** then return ignition state to off

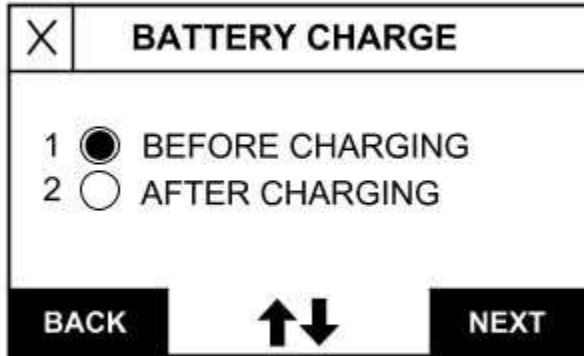

E164374

NOTES:

 BATTERY CHARGE

 If the state of charge is sufficient this step will not show. **Go to next step**

- 11b. **Battery Charge.** Select **Before Charging** if battery has not been on a recommended mains charger for the recommended time shown on the results screen
- Select **After Charging** if battery has been on a recommended mains charger for the recommended time shown on the results screen

 NOTE: For a warranty claim you must supply both before and after test codes in the technical comments box when submitting the claim

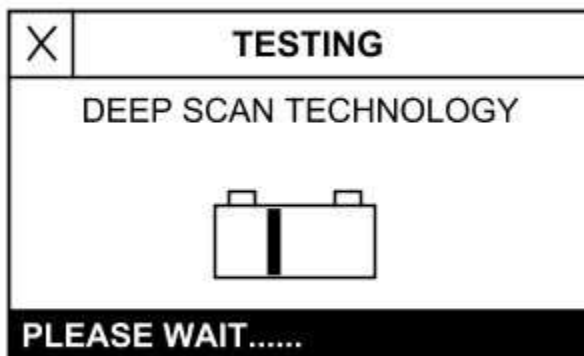

E164375



NOTE: DEEP SCAN TECHNOLOGY

- This may not pop up on the screen and is automated program within the unit



NOTE: This test is automated and will show if required. **Go to next step**

- 12. **Testing.** The EXP-1080 will carry out the deep scan test, then automatically advance when test has completed

Number	Description
1	Battery test result
2	CCA (Measured capacity rating)
3	Voltage
4	CCA (Manually entered)
5	Temperature
6	State Of Charge (SOC)

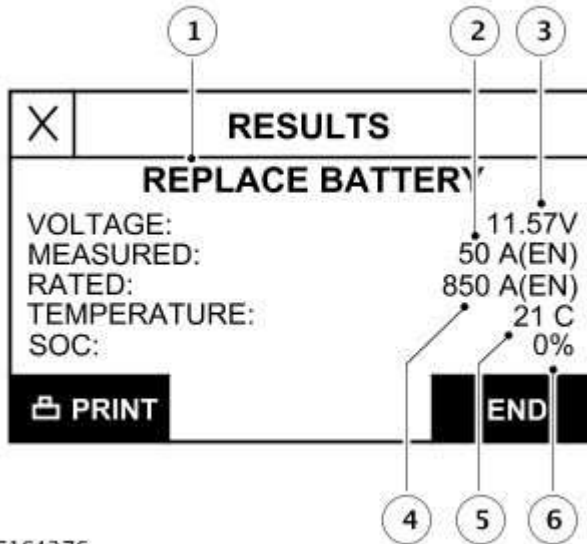

E164376



NOTE: RESULTS

Test Result	Action
GOOD BATTERY	Test complete no action required
CHARGE AND RE-TEST	Charge battery using a recommended mains charger (minimum 50 amp) until charging complete. Retest. If the result is the same replace battery
REPLACE BATTERY / BAD CELL BATTERY	Replace battery. Do Not Recharge
UNABLE TO COMPLETE TEST	Disconnect battery from vehicle and re-test



E164377

NOTES:

 TEST CODE

 Battery test code, must be given if a battery, starter motor or generator is exchanged under warranty

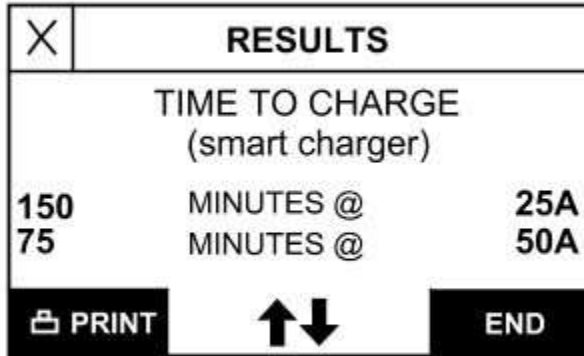

E164378

- 12b. If test result equals "Charge and Re-test" scroll down using the arrow keys to **Time To Charge** screen and follow the **50AMP** charge time for all vehicles apart from **Defender** which can be charged with a 25Amp charger
- **Results** From the result display use the arrow keys on the control panel to view the test code
- The test code **must** be quoted with every battery claim under warranty

Flooded Battery Care Point

If the vehicle is equipped with a flooded battery, ensure the replacement battery is a flooded battery of the same specification (cold cranking amperage (CCA) / amp hour rating (Ah)) as the original battery

Under no circumstances should you fit a flooded battery to a vehicle that originally had an AGM battery, unless formally instructed by Jaguar/Land Rover

AGM Battery Care Point

If the vehicle is equipped with an absorbed glass mat (AGM) battery, ensure the replacement battery is a AGM battery of the same specification (cold cranking amperage (CCA) / amp hour rating (Ah)) as the original battery, unless formally instructed by Jaguar/Land Rover

DTC Index

For a list of Diagnostic Trouble Codes (DTCs) that could be logged on this vehicle, please refer to Section 100-00.

Battery, Mounting and Cables - Battery Disconnect and Connect

General Procedures

Disconnect

1. Refer to: [Battery and Battery Charging Health and Safety Precautions](#) (100-00 General Information, Description and Operation).
2. Obtain and record the audio unit preset radio frequencies.

3.

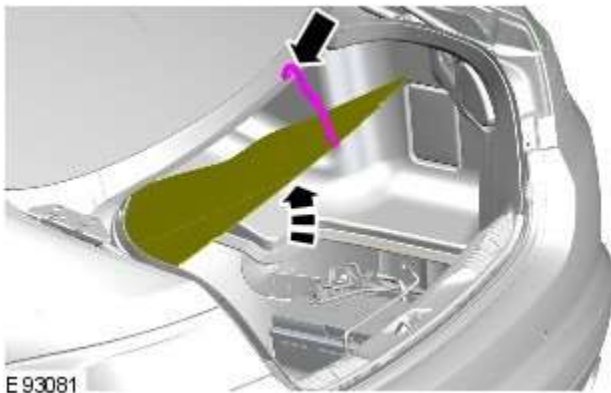

4.  NOTE: Where fitted.

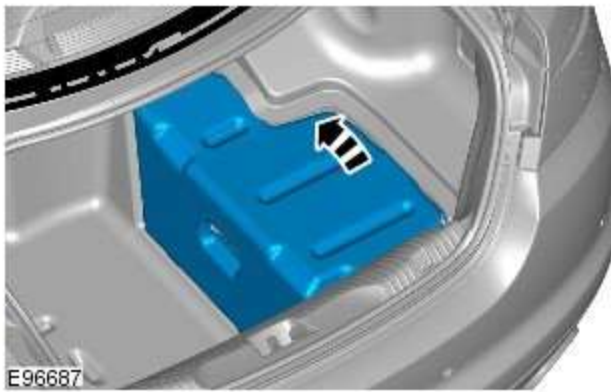



5.  CAUTION: Take extra care not to damage the wiring harness.

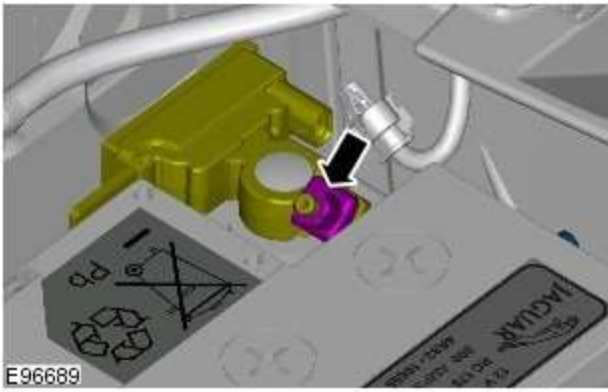



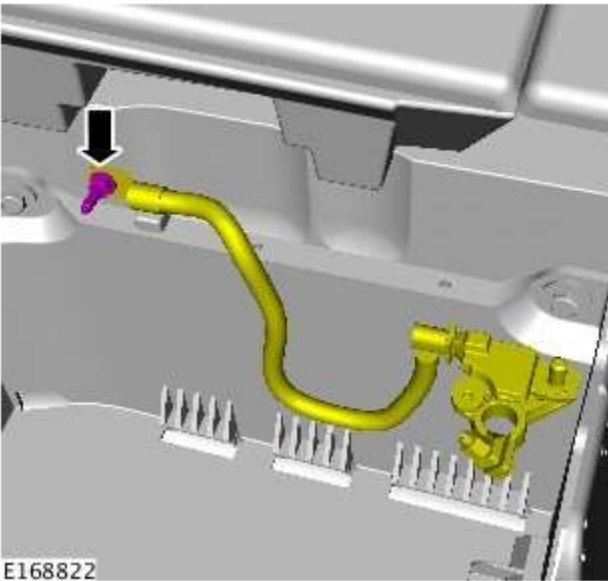

6.

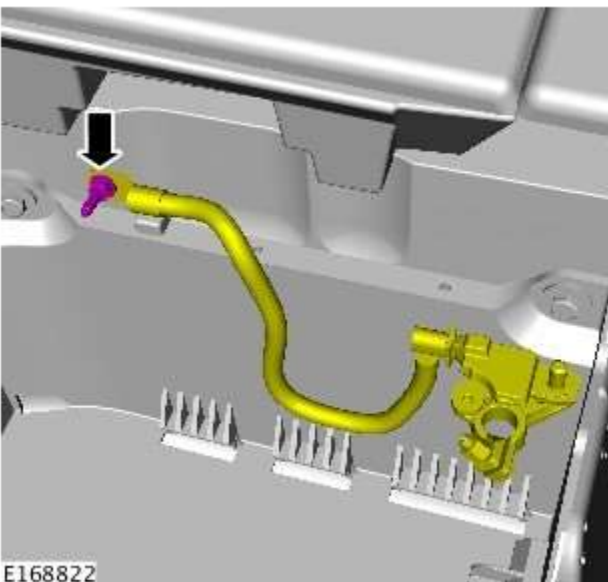

7.  CAUTION: Make sure that the battery negative cable does not move when detaching the negative terminal from the battery.



Connect

1.  CAUTION: Make sure that the battery negative cable to the body retaining bolt is not loose and fully tightened.

Torque: 9 Nm

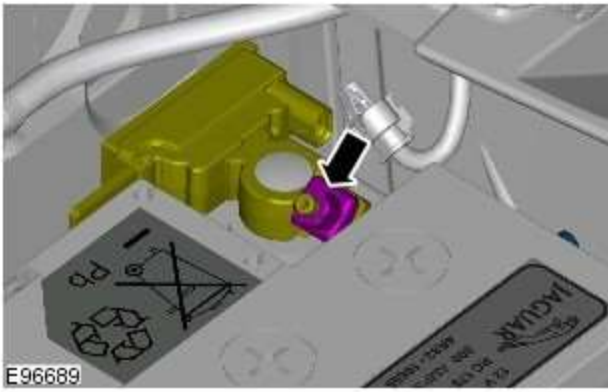

2. *Torque:* 6 Nm

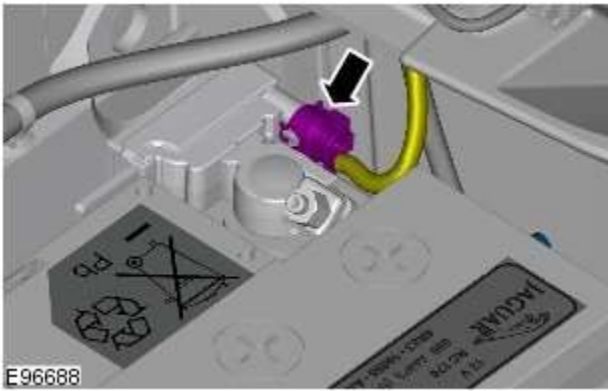

3.

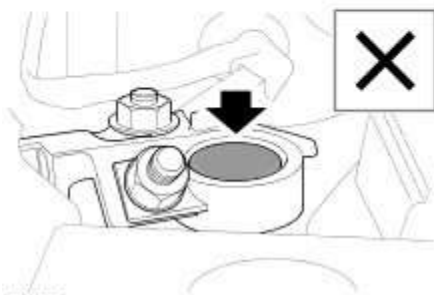
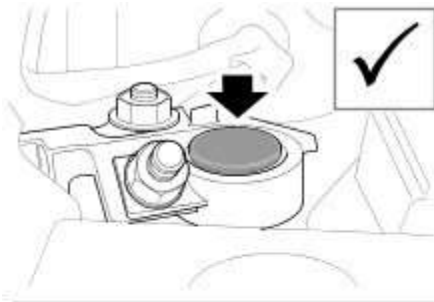

E138396

4.  NOTE: Make sure that both the positive and negative battery terminals are correctly located.

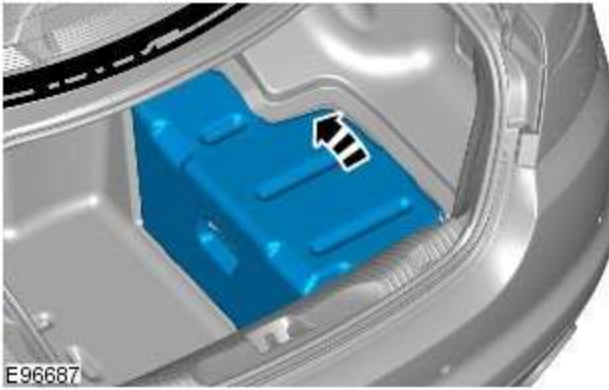

5.  NOTE: Where fitted.

6. NOTE: This step is only necessary when installing a new component.

Using the Jaguar approved diagnostic equipment, reset the battery monitoring system.

7. Refer to: [Door Window Motor Initialization](#) (501-11 Glass, Frames and Mechanisms, General Procedures).

8. Enter the audio unit preset radio frequencies.

9. Reset the clock to the correct time.

10. Start the engine and allow to idle until the engine reaches normal operating temperature.

11. Switch the engine off.

Battery, Mounting and Cables - Battery

Removal and Installation

Removal



NOTE: Removal steps in this procedure may contain installation details.

1. Obtain and record the audio unit preset radio frequencies.

- 2.

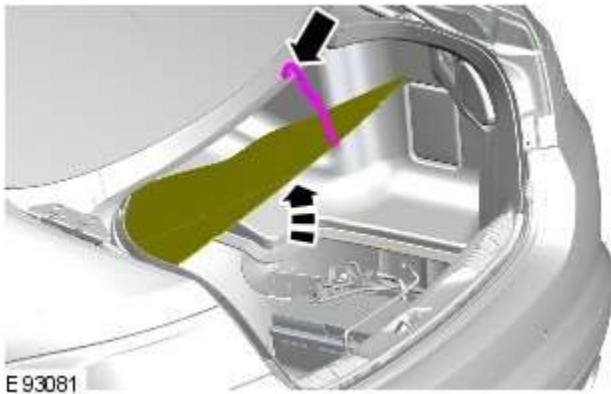

3.  NOTE: Where fitted.

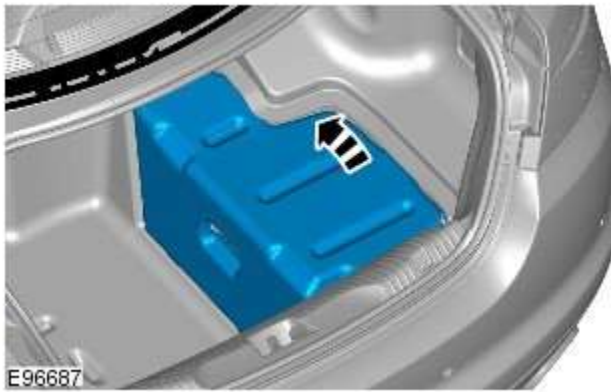

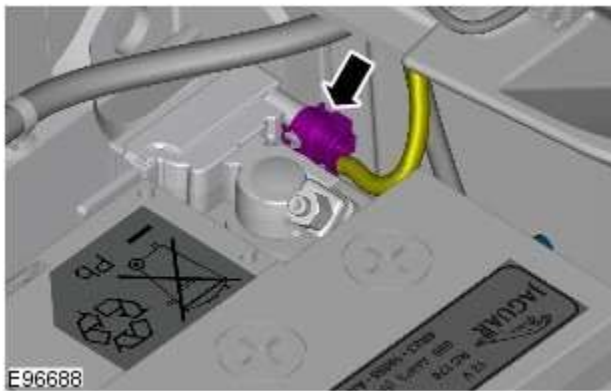

- 4.

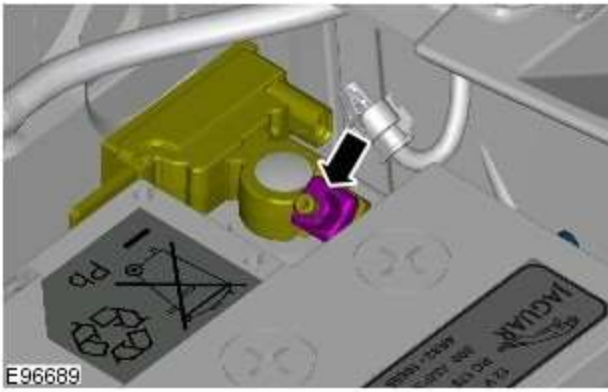

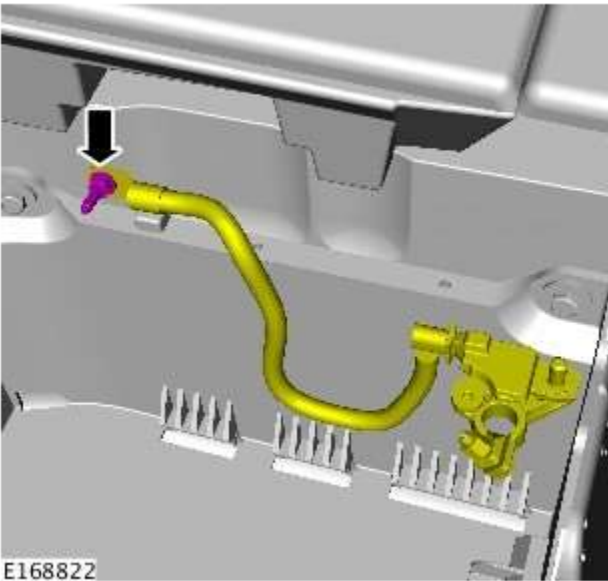

5. *Torque:* 6 Nm



6.  CAUTION: Make sure that the battery negative cable does not move when detaching the negative terminal from the battery.

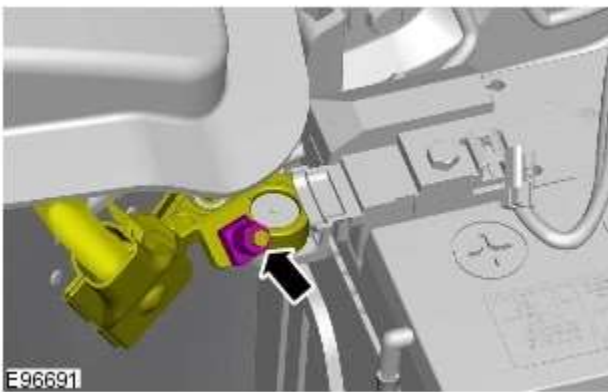

7. *Torque:* 6 Nm

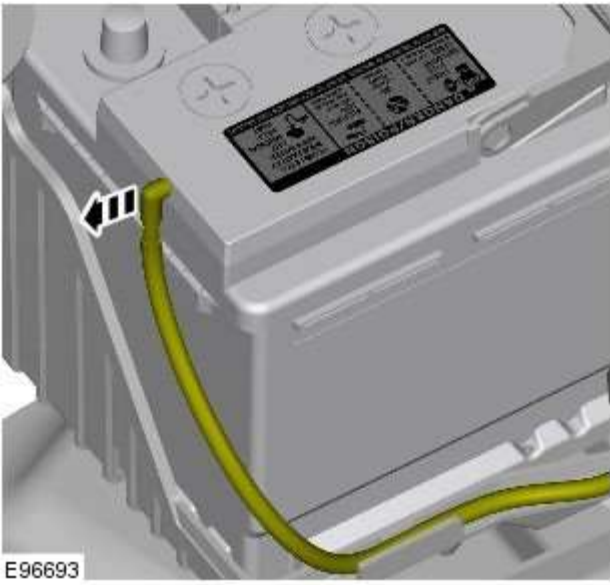

8.

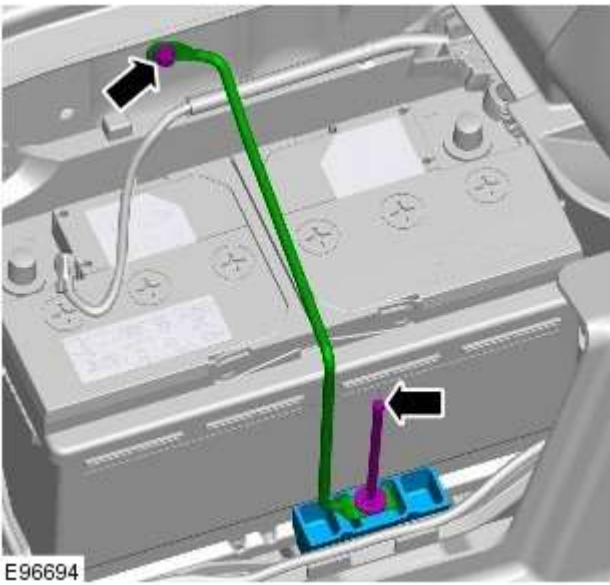

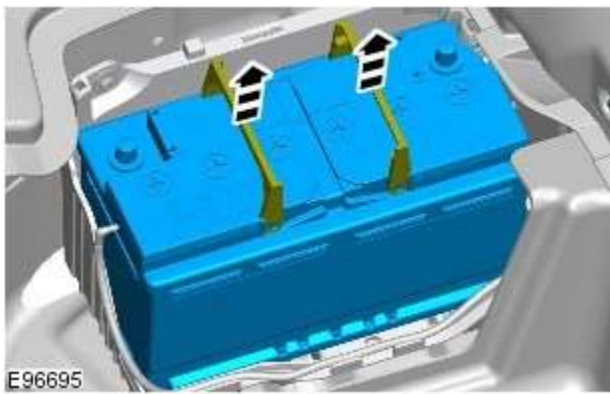

9. *Torque:* 13 Nm

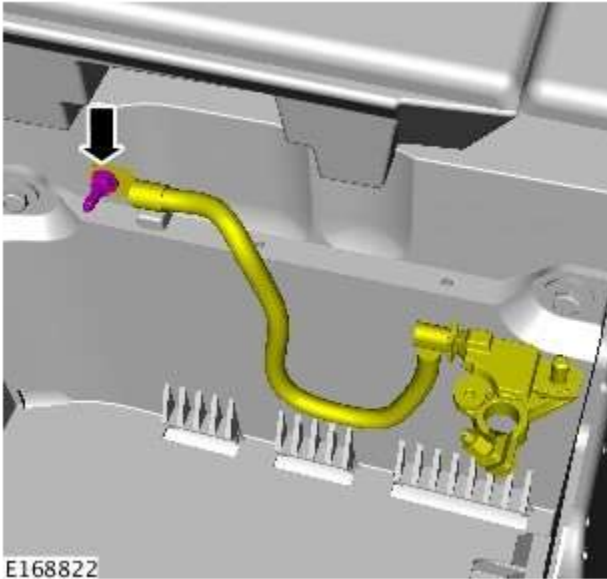

10.

Installation



1.  CAUTION: Make sure that the battery negative cable to the body retaining bolt is not loose and fully tightened.

Torque: 9 Nm

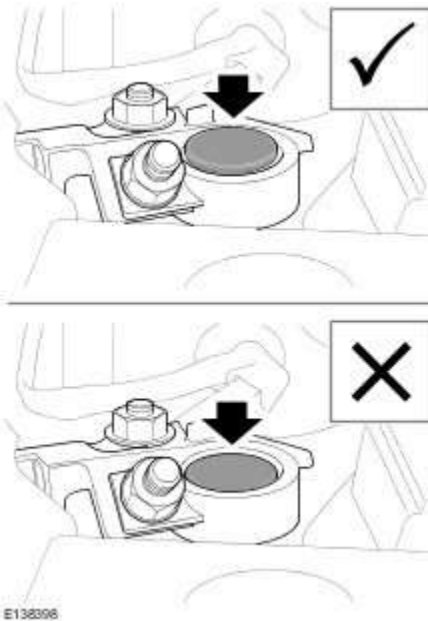

2.  NOTE: Make sure that both the positive and negative battery terminals are correctly located.

To install, reverse the removal procedure.

3.  NOTE: This step is only necessary when installing a new component.

Using the Jaguar approved diagnostic equipment, reset the battery monitoring system.

4. Refer to: [Door Window Motor Initialization](#) (501-11 Glass, Frames and Mechanisms, General Procedures).
5. Enter the audio unit preset radio frequencies.
6. Reset the clock to the correct time.
7. Start the engine and allow to idle until the engine reaches normal operating temperature.
8. Switch the engine off.

Generator and Regulator - V8 5.0L Petrol/V8 S/C 5.0L Petrol -

Description	Nm	lb-ft	lb-in
Generator retaining bolts	47	35	-
Battery positive cable retaining nut	12	9	-

Generator and Regulator - V8 5.0L Petrol/V8 S/C 5.0L Petrol - Generator - Component Location

Description and Operation

COMPONENT LOCATION

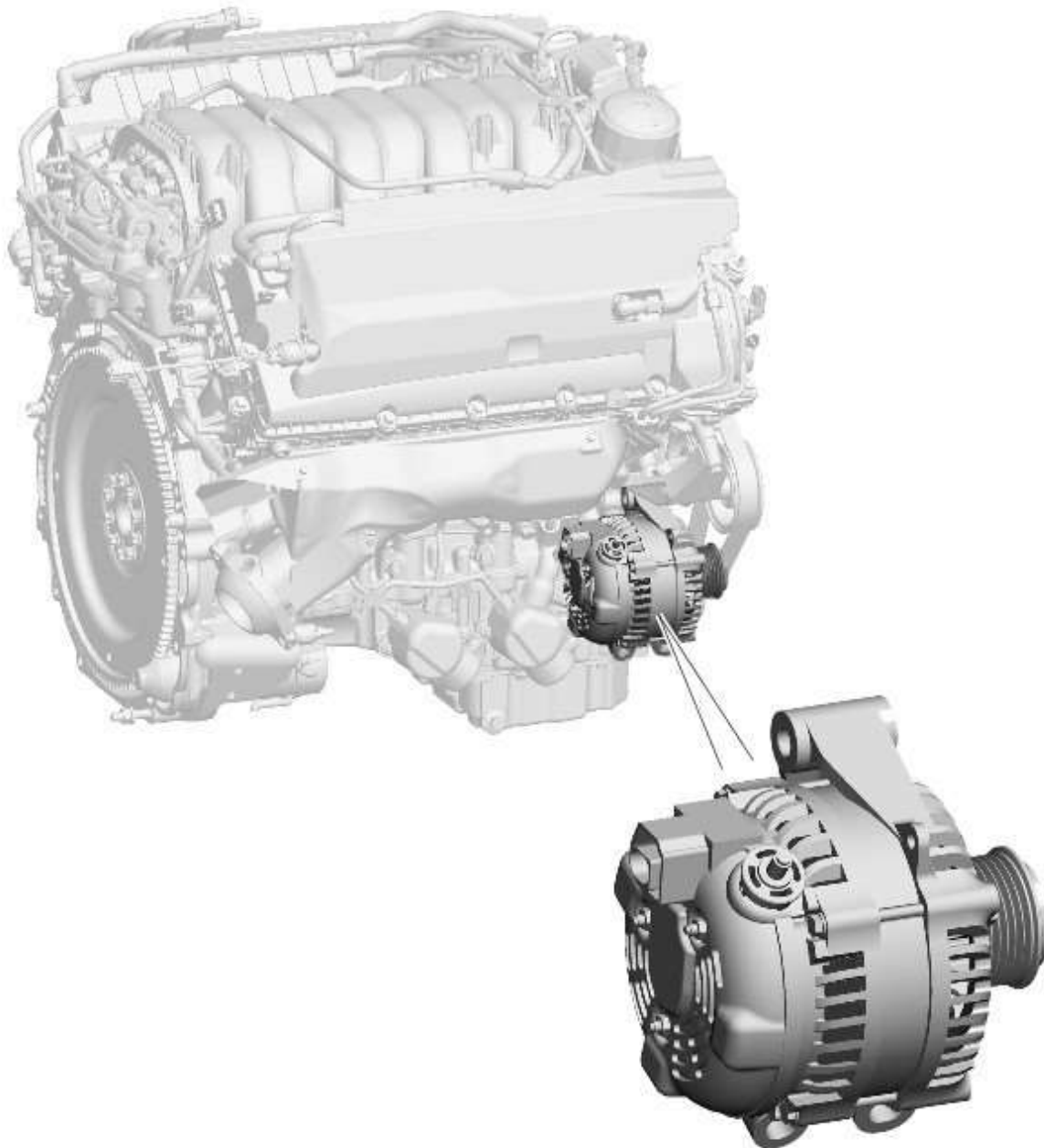

E118331

Generator and Regulator - V8 5.0L Petrol/V8 S/C 5.0L Petrol - Generator -

Overview

Description and Operation

OVERVIEW

On 5.0L V8 vehicles (naturally aspirated and supercharger), the charging system consists of a 150 Amp output generator and regulator assembly. The generator and regulator assembly generates electrical power for the vehicle electrical system and maintains the battery in a charged state.

When the engine is running the generator produces an alternating current, which is converted to a direct current internally. The output from the generator is controlled by the voltage regulator (located inside the generator) and then supplied to the battery through the main battery positive cable. The generator is mounted on the front right side of the engine and driven at approximately 3 times engine speed by the accessory drive belt.

Generator and Regulator - V8 5.0L Petrol/V8 S/C 5.0L Petrol - Generator - System Operation and Component Description

Description and Operation

Control Diagram

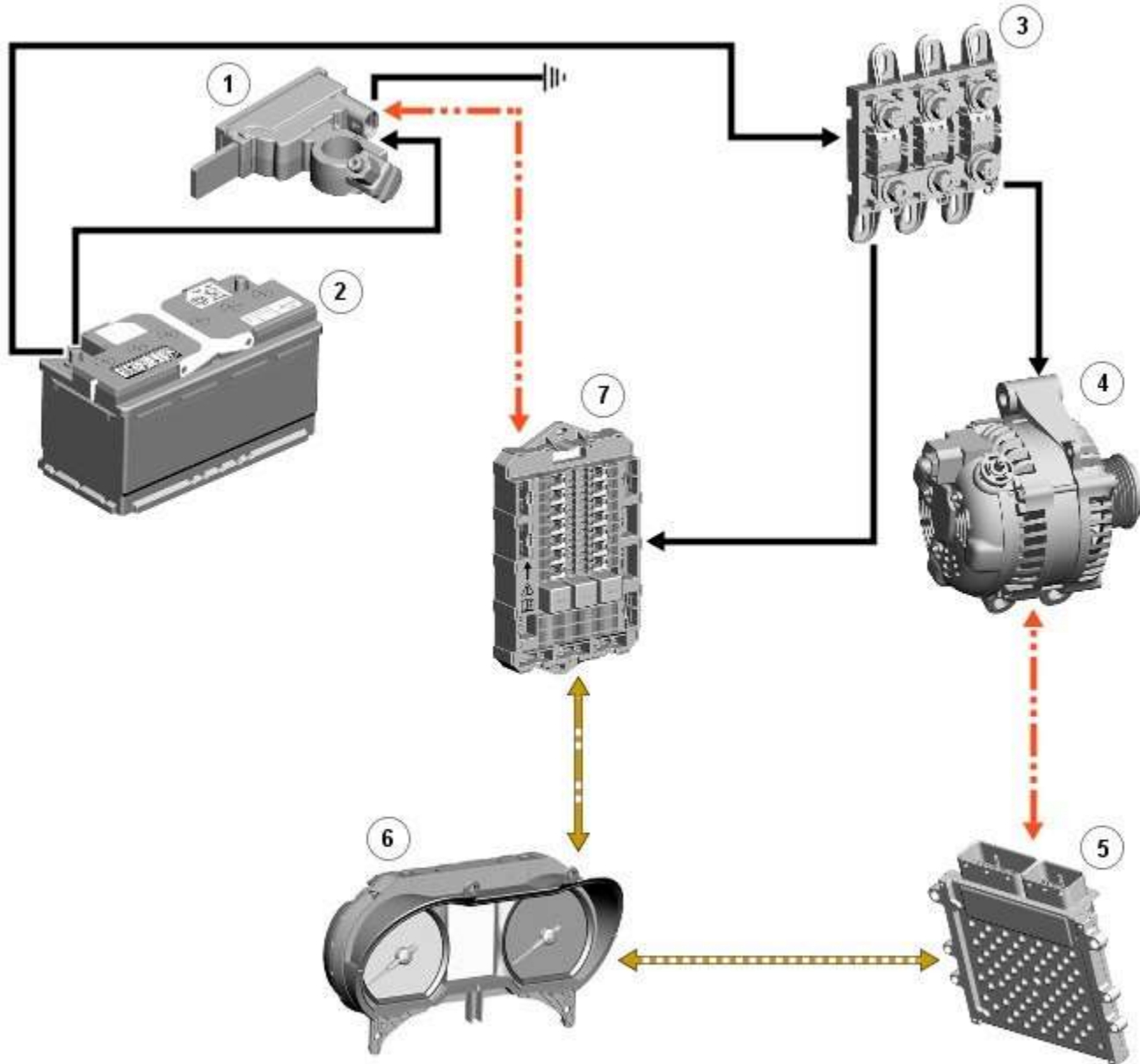

NOTE: **A** = Hardwired; **D** = High speed CAN (controller area network) bus; **N** = Medium speed CAN bus; **O** = LIN (local interconnect network) bus

D

E118332



Item	Description
1	Battery monitoring system module
2	Battery
3	BJB (battery junction box)
4	Generator and regulator
5	ECM (engine control module)
6	Instrument cluster
7	RJB (rear junction box)

System Operation

GENERAL

The output voltage required from the generator and regulator is calculated by the battery monitoring system. For additional information refer to Battery, Mounting and Cables 414-01.

The battery monitoring system signals the calculated voltage to the [ECM](#) via the [RJB](#) and the instrument cluster. The [ECM](#) then transmits the calculated voltage to the generator and regulator on the [LIN](#) bus connection.

The [ECM](#) will over-ride the voltage value requested by the battery monitoring system if it detects a fault in the generator and regulator. The [ECM](#) also signals the instrument cluster to display a warning message if it detects a fault with the generator and regulator. For additional information refer to Instrument Cluster 413-01.

Component Description

GENERATOR AND REGULATOR

The regulator provides a controlled variable voltage output from the generator. Two electrical terminals are provided on the outer casing of the generator. One terminal supplies the [DC \(direct current\)](#) voltage output from the generator to the battery positive terminal. The second terminal provides the [LIN](#) bus connection between the regulator and the [ECM](#).

Generator and Regulator - V8 5.0L Petrol/V8 S/C 5.0L Petrol - Generator V8 S/C 5.0L Petrol

Removal and Installation

Removal

NOTES:



Removal steps in this procedure may contain installation details.



Some variation in the illustrations may occur, but the essential information is always correct.

1. Refer to: [Battery Disconnect and Connect](#) (414-01 Battery, Mounting and Cables, General Procedures).



2. **WARNING:** Make sure to support the vehicle with axle stands.
Raise and support the vehicle.

3. Refer to: [Air Deflector](#) (501-02 Front End Body Panels, Removal and Installation).

4. **Torque:** 12 Nm

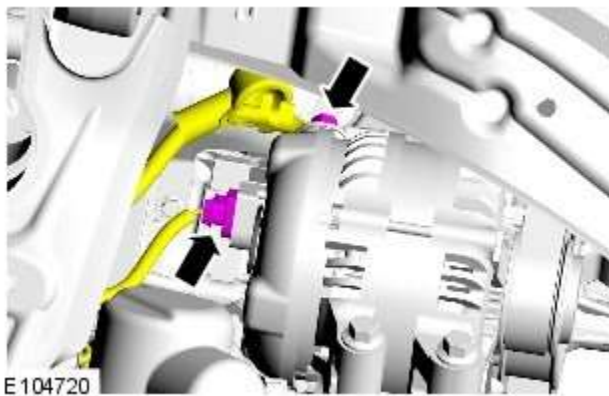

- 5.

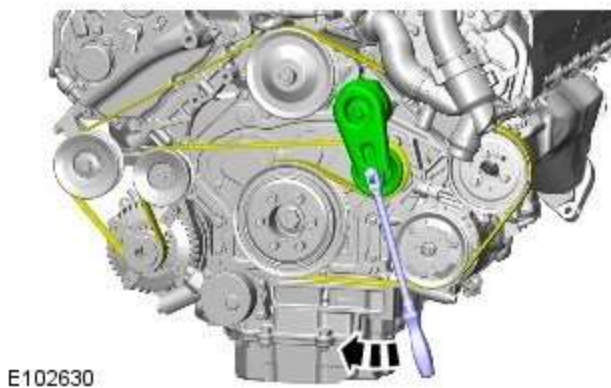



6.  NOTE: Tighten the bolts in the indicated sequence.

Torque: 48 Nm

Installation

1. To install, reverse the removal procedure.