

ZF Trouble Shooting Guide

JLR 13 18 10_3E

General Information

The ZF Trouble Shooting Guide (TSG) is a knowledge-based system. It is designed to aid diagnosis of transmission-related faults which have previously been encountered with ZF products in Jaguar applications.

The guide is intended to cover 6 speed transmission vehicles, which include the following;

X100	XK Series
X150	New XK/ XK/ XKR
X200	S-Type
X250	XF
X350	XJ

This file is intended as a supplement to the workshop manuals; specifically to accompany the Description & Operation, and Diagnosis and Testing sections.

It covers problems with both the transmissions themselves, and vehicle-related problems.

It has been compiled using information learned from investigations during assembly, field cases and at dealerships. The guide is a supplement based on 'real time' field issues and as such it will be updated on a regular basis.

If you have comments or questions relating to this publication please use the 'contact us' button on GTR.

September 2007

Blank Page

CARRY OUT HARD RESET – CLEAR ENGINE ADAPTIONS

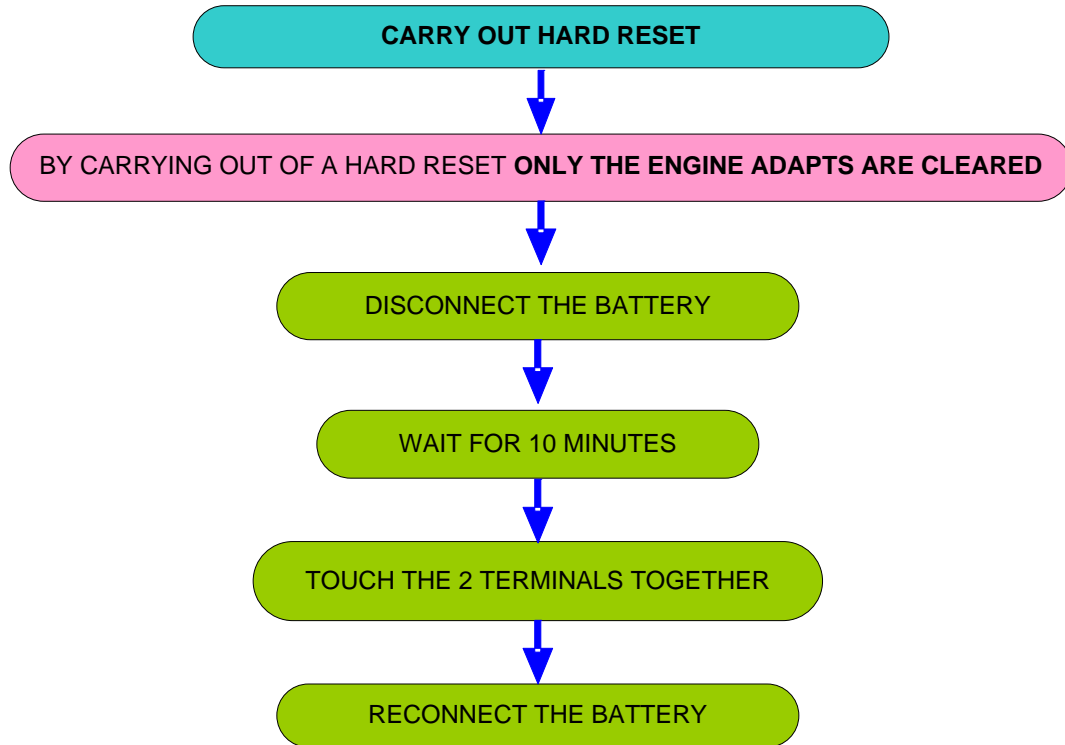

THE TRANSMISSION ADAPTIONS
ARE NOT CLEARED BY
CARRYING OUT A HARD RESET

THE TRANSMISSION ADAPTIONS
MUST BE CLEARED BY USING
THE DEALER SPECIAL TOOL
(SPECIAL APPLICATION OPTION)

CLEAR THE TRANSMISSION ADAPTATION VALUES

**„THE GOLDEN 6HP26 RULE“:
BEFORE FLASHING A TRANSMISSION
THE TRANSMISSION ADAPTIONS MUST BE RESET WITHOUT EXCEPTION**

CLEAR THE TRANSMISSION ADAPTIONS



THE TRANSMISSION ADAPTIONS ARE NOT CLEARED BY CARRYING OUT A HARD RESET



THE TRANSMISSION ADAPTIONS MUST BE CLEARED MANUALLY



USE THE DEALER SPECIAL TOOL
(SPECIAL APPLICATION OPTION)

2_1 ROLL OUT SHUNT ON PETROL CARS

2-1 ROLL OUT SHUNT, POOR SHIFTS 3-2 & 2-1: ALL PETROL APPLICATIONS

CHECK AIR INTAKE HOSE - ENSURE IN POSITION AND SECURE

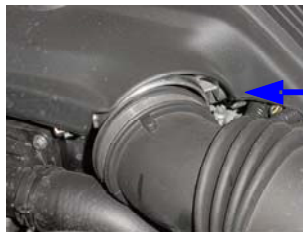

EXAMPLE: INTAKE PIPE ADRIFT FROM THROTTLE BODY

INTAKE ADRIFT

REFIT INTAKE PIPE AND SECURE

CARRY OUT HARD RESET
(TO CLEAR THE ENGINE ADAPTATIONS)
→ SEE GENERAL INFORMATION

INTAKE IN POSITION AND SECURE

RESET THE TRANSMISSION ADAPTATIONS
(WITH DEALER SPECIAL TOOL)
→ SEE GENERAL INFORMATION

FLASH WITH „SHIFT ADAPTS FIX“ SOFTWARE
WDS DISC 42 ONWARDS
→ USE TABLE SOFTWARE FIX (ALL APPLICATIONS)

CARRY OUT CAR SPECIFIC ADAPTION PROCEDURE
→ SEE GENERAL INFORMATION

FAULT CODES P0720, P0730, P0780 LOGGED (DIFF)

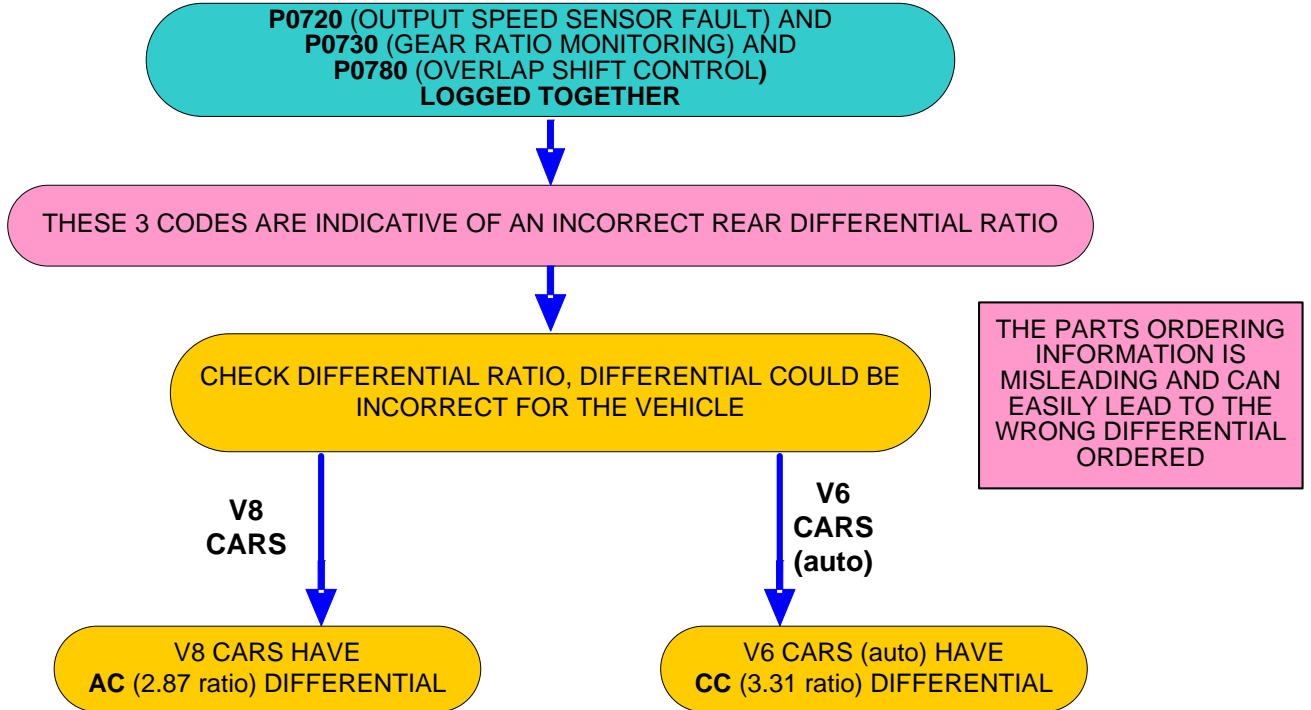

Differential identification



A = diff for 4.2 V8
C = diff for 3.0 V6

HARSH ROLL OUT SHIFTS AND/OR SQUAWK NOISE AND/OR SHUDDER

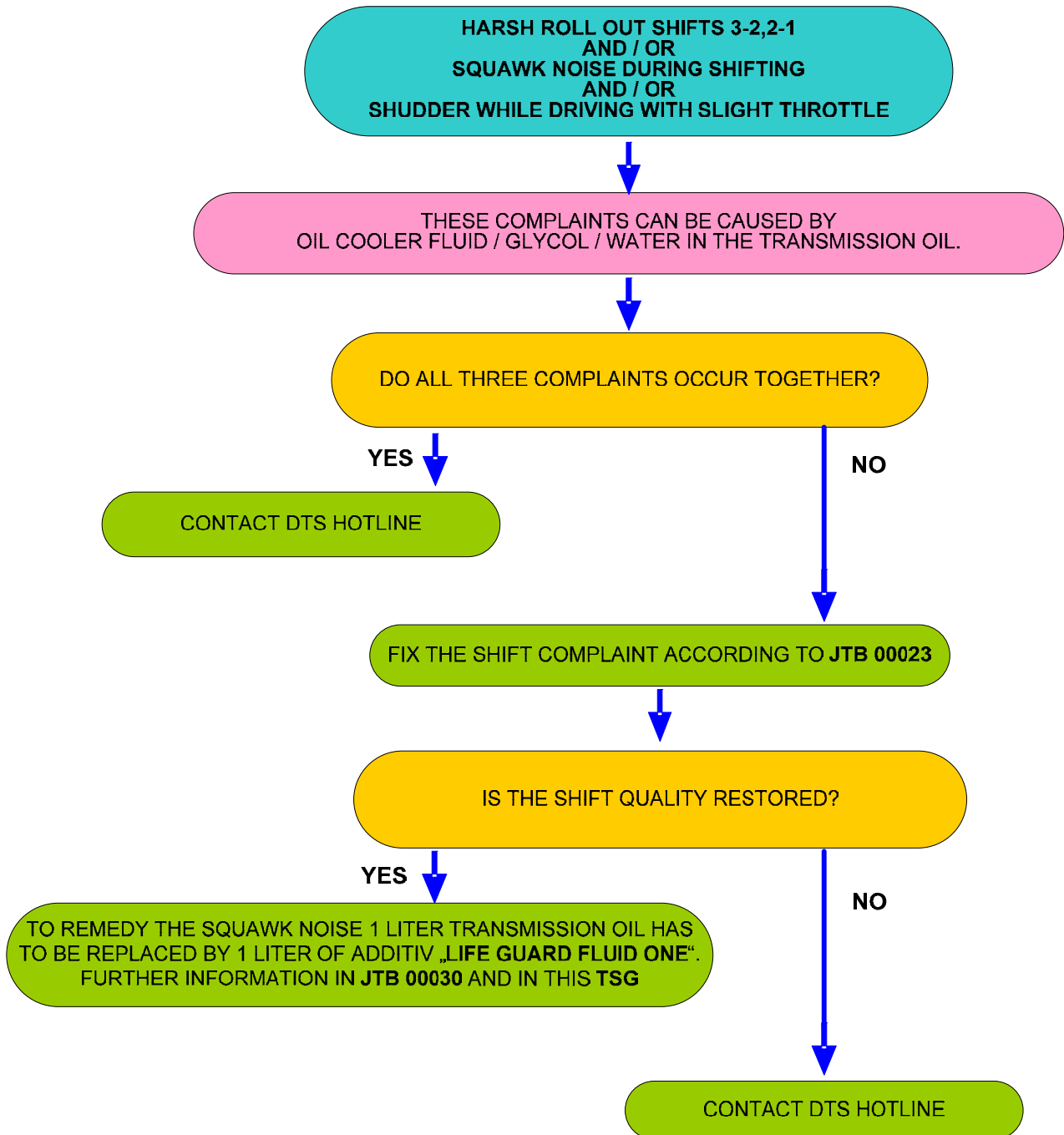

INTERRUPTION OF DRIVE OR MOMENTARY LOSS OF TRACTION - THUMPS

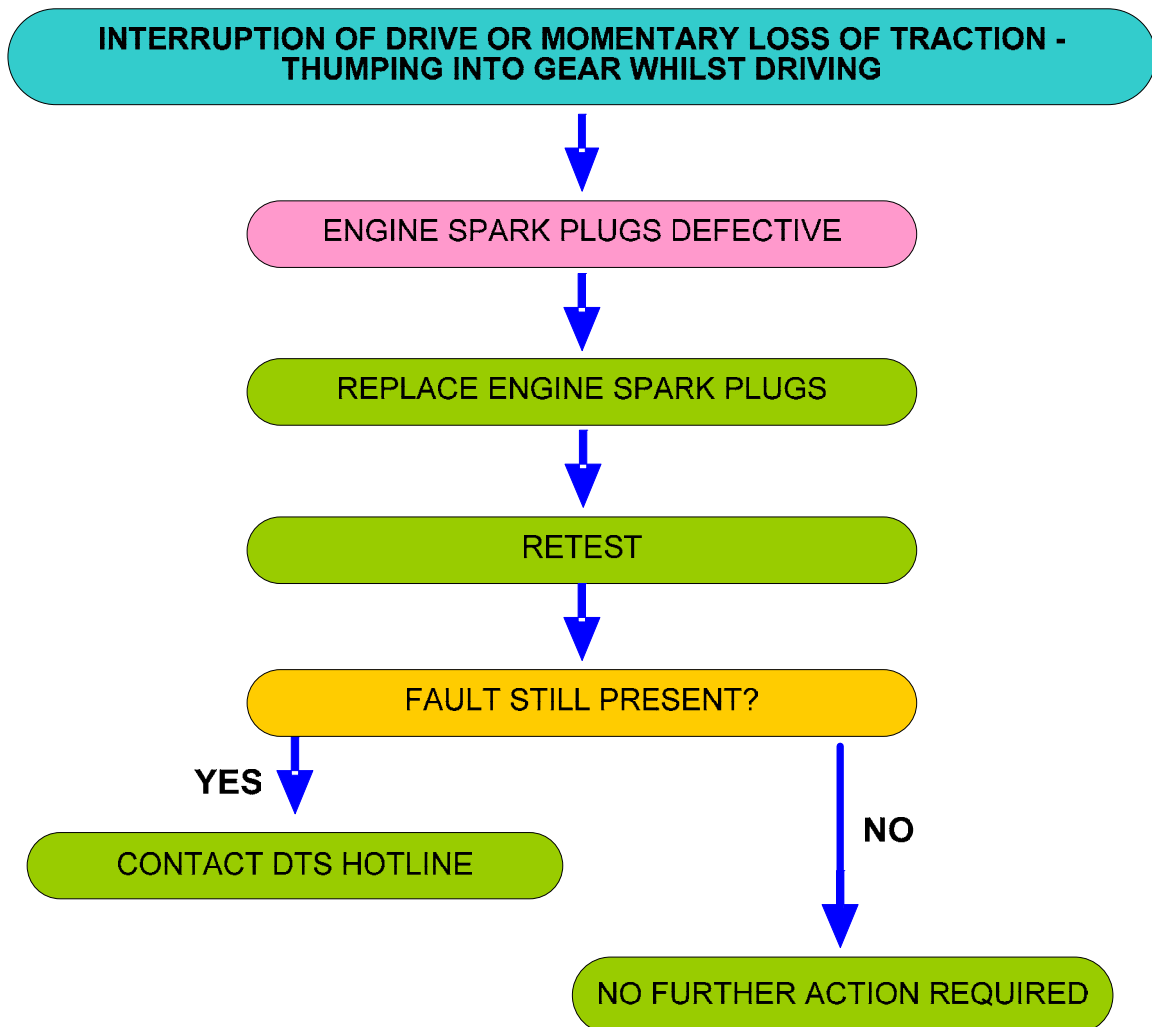

NO UPSHIFT AFTER ACCELERATION

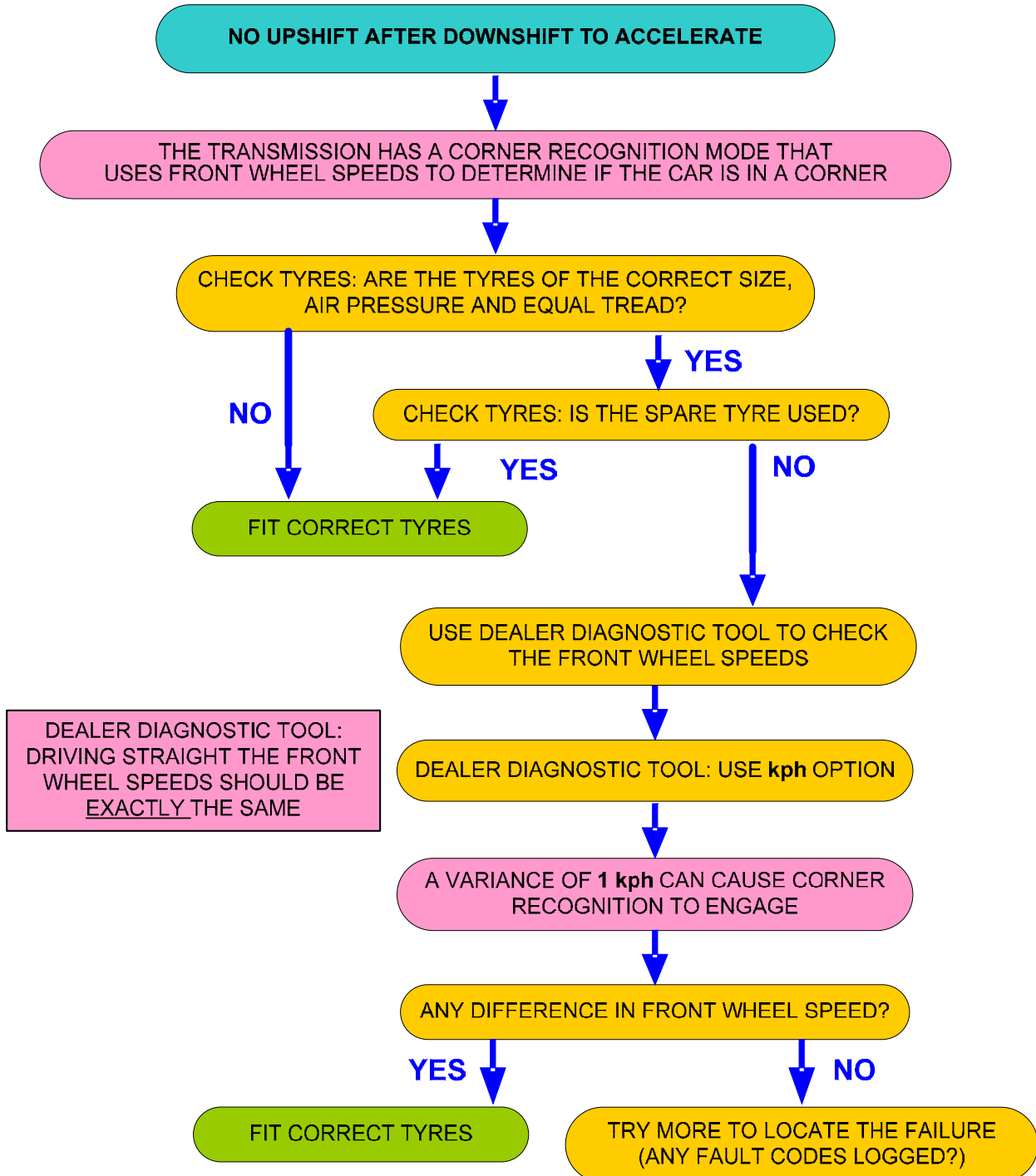

SQUAWK NOISE SHIFTING IN OR OUT 3RD GEAR (ADDITIVE)

SQUAWK NOISE WHEN SHIFTING IN OR OUT OF 3RD GEAR (3-4, 4-3, 5-3)

THE NOISE IS CAUSED BY CHANGES IN THE SLIPPAGE CHARACTERISTIC OF THE TRANSMISSION OIL

1 LITER TRANSMISSION OIL HAS TO BE REPLACED BY 1 LITER OF ADDITIV „LIFE GUARD FLUID ONE“ (PART NO.: C2C 37157; ZF NO.: S671.090.2889)

REFER TO JAGUAR SERVICE BULLETIN **JTB00040V3** FOR EXCHANGE PROCEDURE AND CHECK VIN RANGE IF USE OF ADDITIV IS ALLOWED!

AFTER EXCHANGE PROCEDURE
CHECK FLUID LEVEL AGAIN

REFILL TRANSMISSION WITH OIL IF NECESSARY. FOR CHECKING FLUID LEVEL REFER TO GTR WORKSHOP MANUAL SECTION 307-01

SQUEAK FROM TRANSMISSION AREA AT LOW SPEED (WALKING PACE)

SQUEAK FROM TRANSMISSION AREA AT LOW SPEED, WALKING PACE

BODY SEALANT POSSIBLY RUBBS AT TUBE UNDER PROPSHAFT HEAT SHIELD

REMOVE PROPSHAFT HEAT SHIELD AND CHECK TUBE FOR EVIDENCE OF RUBBING BY BODY SEALANT



SEALANT

SEALANT ATTACHED HERE

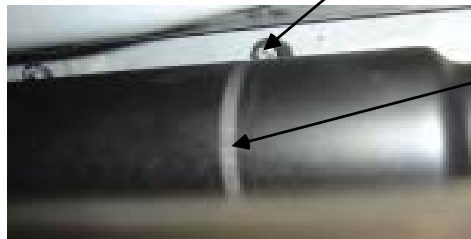

RUB MARK ON PROPSHAFT

REMOVE BODY SEALANT

SURGE ON FIXED LIGHT THROTTLE

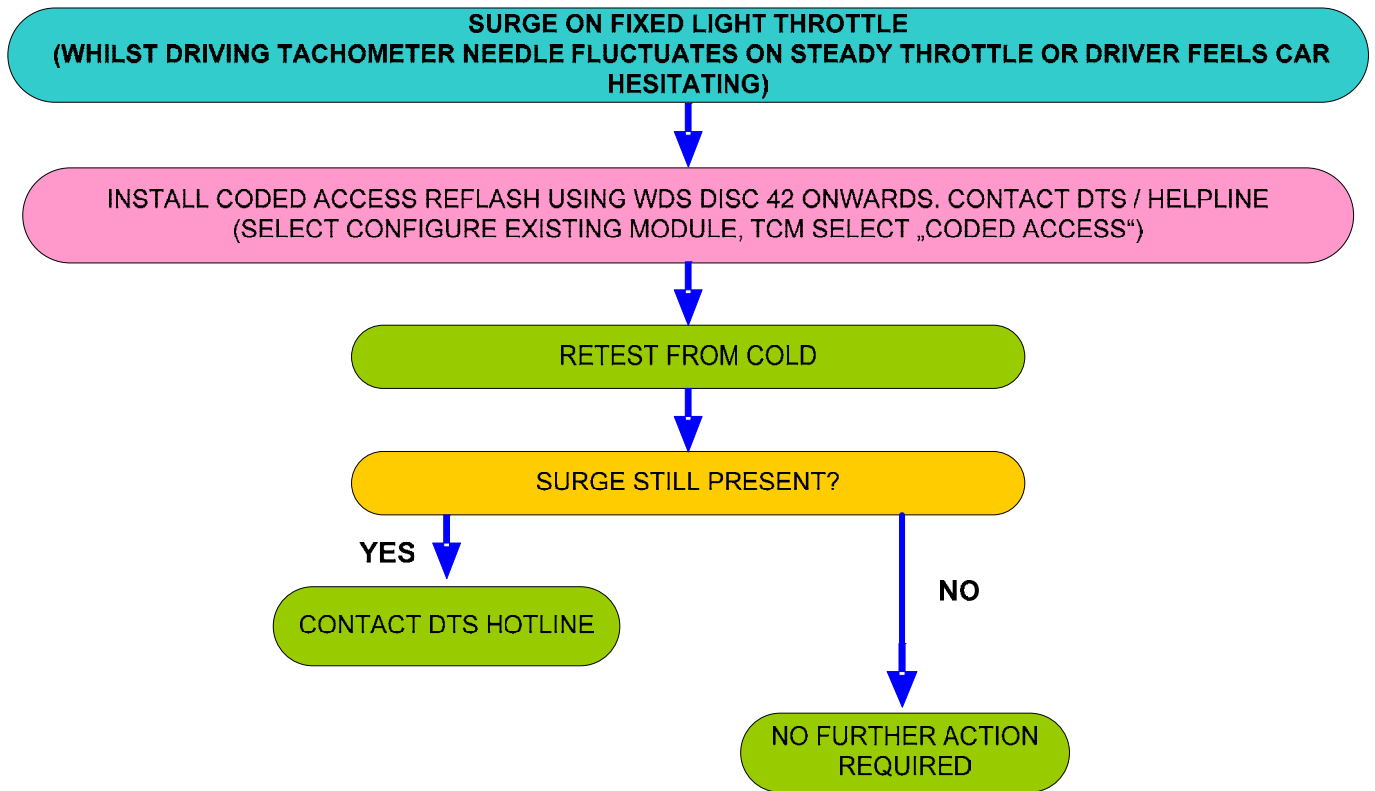

TRANSMISSION WARNING LIGHT ON (NA AND SC CARS)

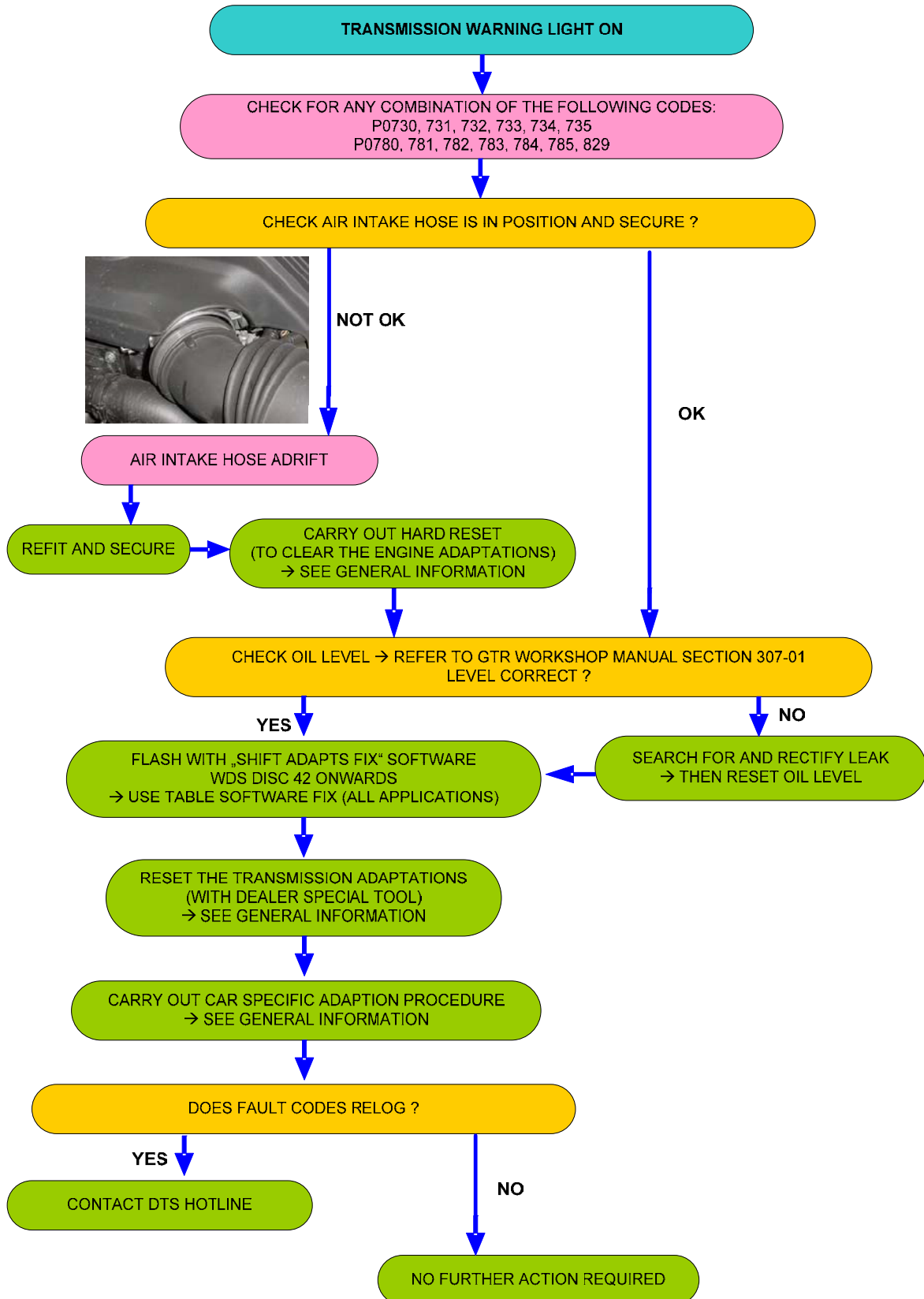

ZF Trouble Shooting Guide
General Information
(All Applications)

ZF Trouble Shooting Guide
General Information
(This Application Only)

DRIVE SELECTOR AND EPR

X250 - COMPONENT LOCATION DRIVE SELECTOR (SHIFT BY WIRE) AND EMERGENCY PARK RELEASE

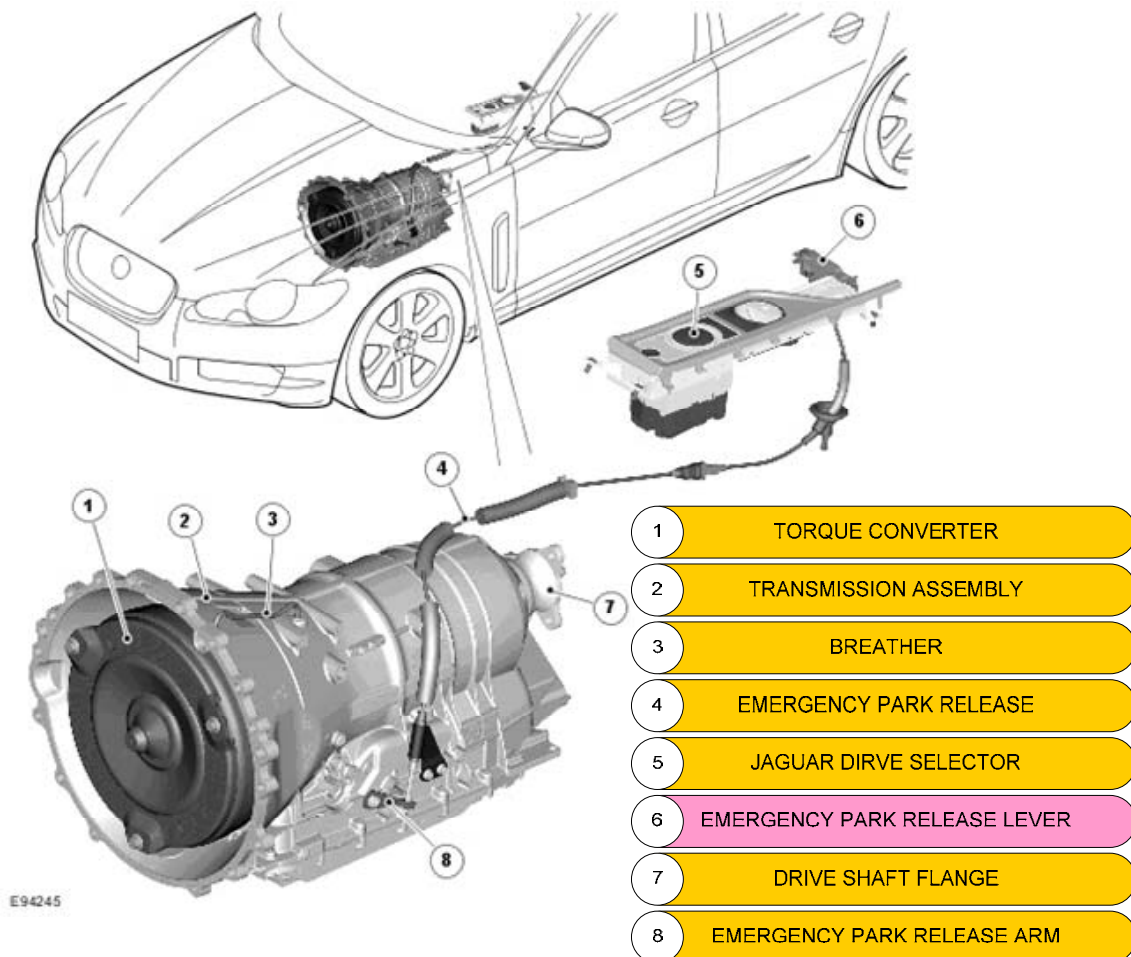

WHEN THE TRANSMISSION IS FUNCTIONING CORRECTLY AND THE EMERGENCY PARK RELEASE LEVER IS PULLED TO ALLOW MOVEMENT OF THE VEHICLE - IF THE IGNITION IS KEYED ON - **DTC 1707-77** WILL BE ACTIVATED.

THIS IS **NOT** A TRANSMISSION FAULT.

THE EMERGENCY RELEASE LEVER IS DESIGNED TO BE USED ONLY IN EVENT OF ENGINE NON START ELECTRICAL FAILURE OR PERMANENT TRANSMISSION DEFAULT.

SOFTLOCK FUNCTION

SOFTLOCK FUNCTION

IF THE BRAKE PEDAL PRESSURE IS RELAXED AS THE GEAR SELECTOR IS MOVED INTO D OR R, THE DRIVER MAY EXPERIENCE NO DRIVE AND THE RED SELECTOR ILLUMINATION LIGHT WILL BLINK

THIS IS **NOT** A TRANSMISSION FAULT

BRAKE PEDAL PRESSURE MUST BE MAINTAINED **DURING SELECTION OF D OR R**. CORRECT SELECTION OF D OR R IS ACCOMPANIED BY STEADY ILLUMINATION OF THE RED SELECTOR POSITION LIGHT

