

BMW 6HP26 – 6HP28 Transmission fluid level procedures

A) Transmissions fluid level checking.

- 1) The transmission fluid temperature must be between 30°C and 35°C before checking can begin. Use test equipment to determine the trans temperature.
- 2) The vehicle must be level with engine running at idle speed and air conditioning turned on.
- 3) Step on the brakes firmly, apply parking brake fully and shift to D and R, briefly pausing in each position before shifting back to the Park position.
- 4) With the engine running at idle speed and the selector in Park position, remove the filler plug. Monitor the transmission temperature, if a small stream of oil runs out at 40°C, the fluid level is correct.
- 5) If no oil runs out when the filler plug is removed, the fluid level is too low and oil needs to be added until it overflows.
- 6) With engine running, install the oil filler plug and tighten to proper torque.

B) Adding fluid after repairs.

- 1) With the engine stopped and the transmission in Park position, remove the oil filler plug. Add transmission fluid until a small stream of oil runs out.
- 2) Insert the filler plug and tighten by hand. Start the engine.
- 3) With the engine running, remove the oil filler plug and add transmission fluid until a small stream of oil runs out. Insert the filler plug and tighten by hand.
- 4) Follow the “Transmission fluid level checking” procedure described in section A) above.

C) Notes on fluid level and adding procedure.

- 1) Use only ZF-LifeguardFluid6 or OE approved transmission fluid.
- 2) If the transmission temperature rises above 50°C during the fluid level checking procedure the resulting oil level will be too low. Let the transmission cool down and repeat the fluid level procedure.
- 3) Have transmission fluid and a suitable oil pump available before starting the fluid level procedure. The transmission fluid temperature will rise quickly during the checking procedure.

D) Drain and filler plug location.

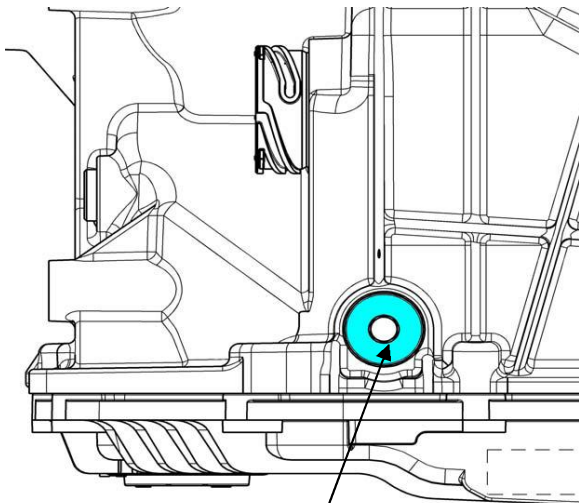

Filler plug **M18x1.5**
Inner hexagon **8mm**
Tightening torque **35 Nm ± 3.5 Nm**

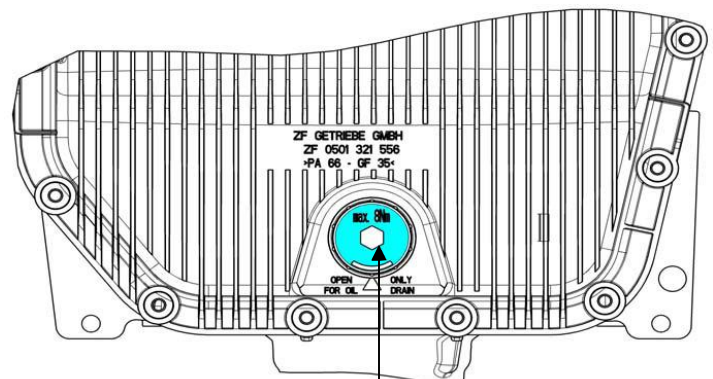

Drain plug **M24x1**
Inner hexagon **10mm**
Tightening torque **8 Nm - 0.5 Nm**