

Floor Console 76.25.01

Removal

All vehicles

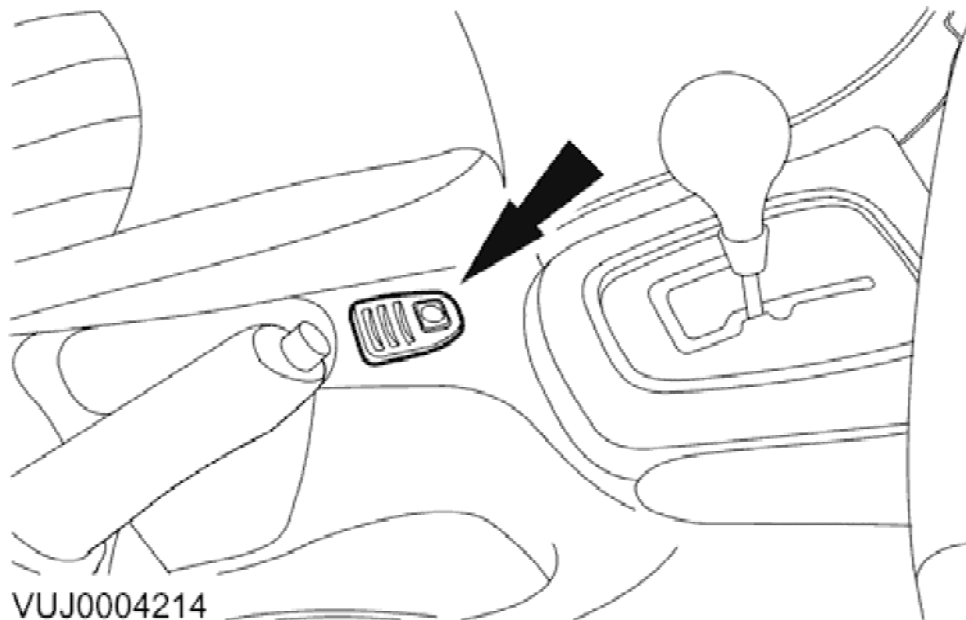

VUJ0004214

1. Detach the PATS light.

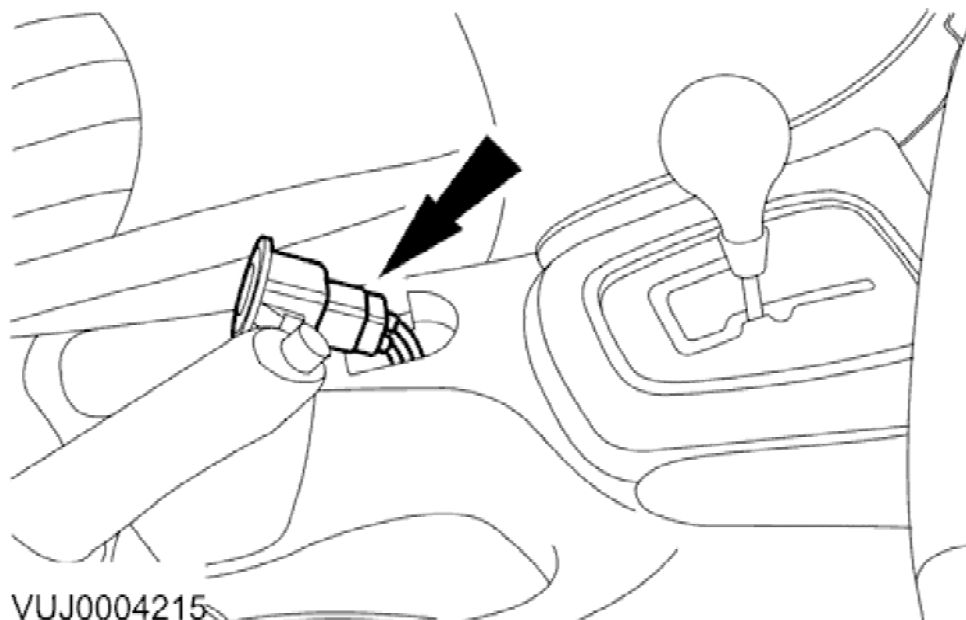

VUJ0004215

2. Remove the PATS light.
1. Disconnect the electrical connector.
2. Remove the PATS light.

2004 X-TYPE - Instrument Panel and Console - 501-12

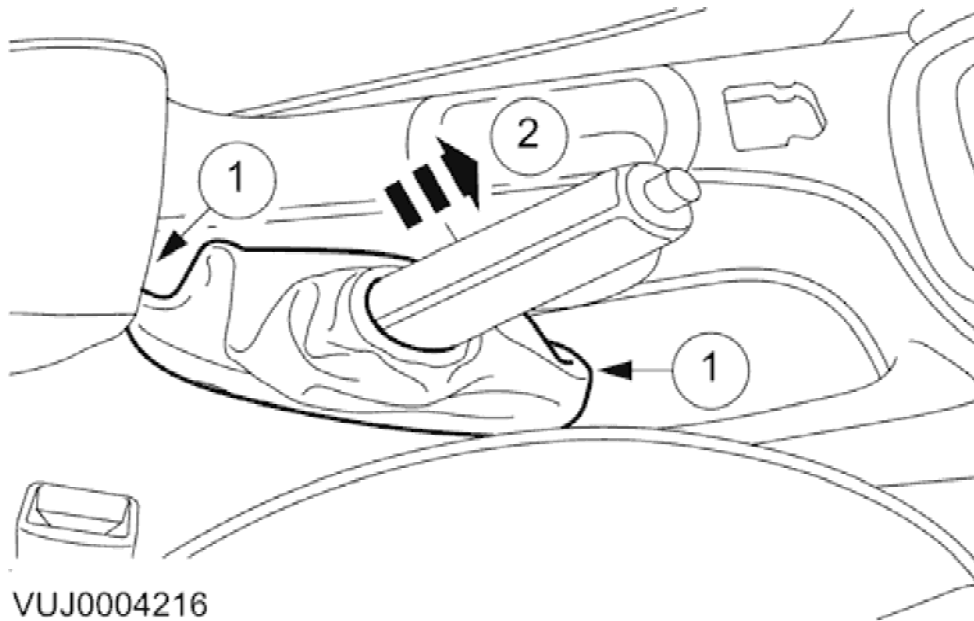

3. Remove the hand brake lever surround.

1. Detach the hand brake lever surround.

2. Remove the hand brake lever surround.

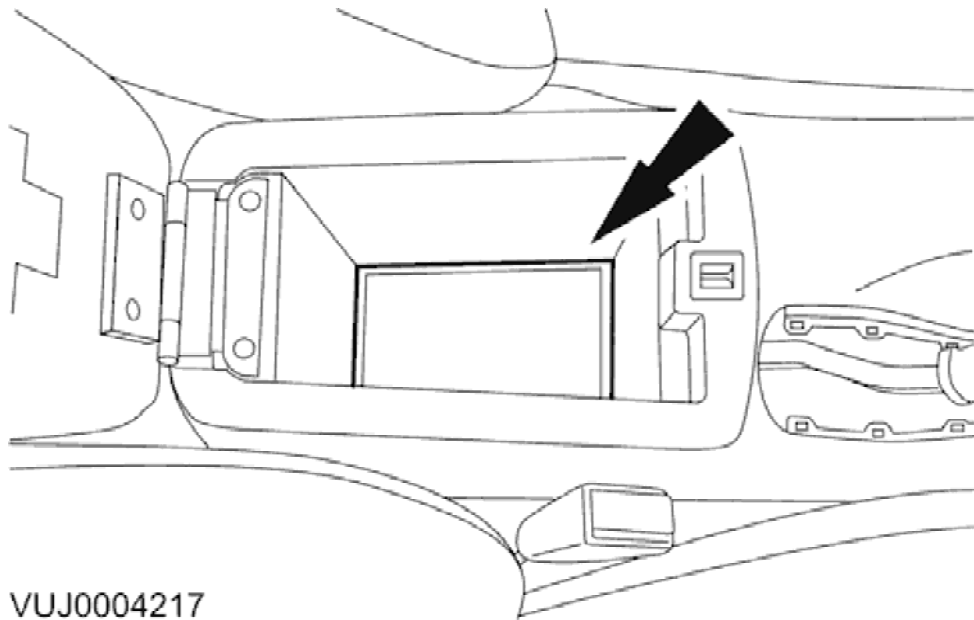

4. Remove the console stowage compartment non slip mat.

2004 X-TYPE - Instrument Panel and Console - 501-12

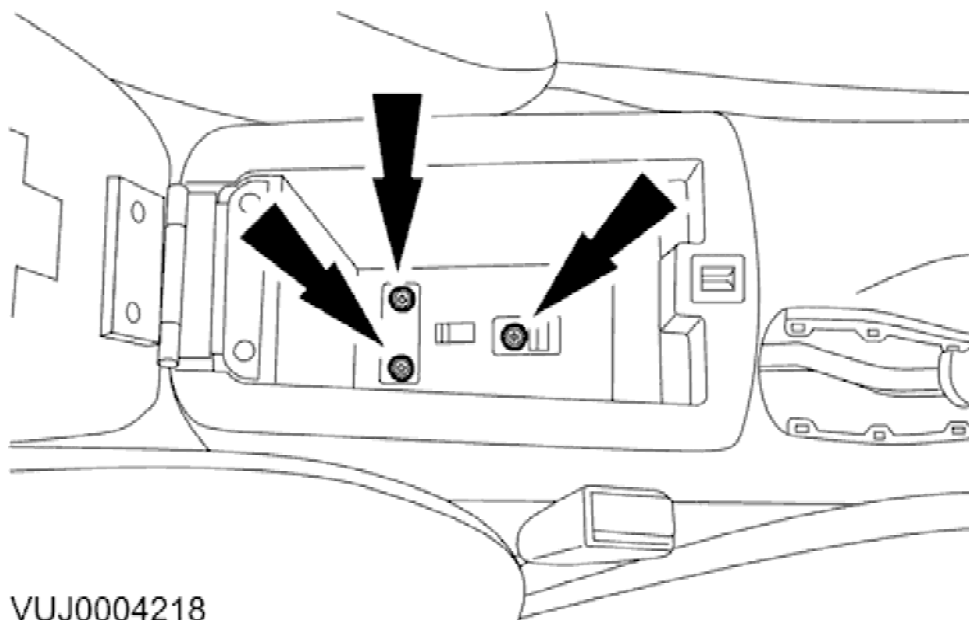

VUJ0004218

5. Remove the retaining screws.

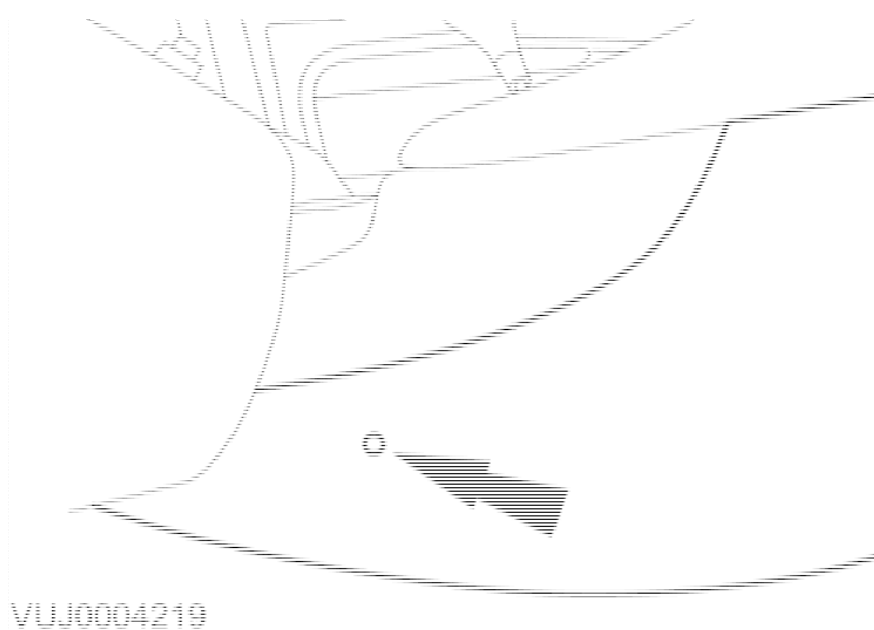

VUJ0004219

6. Remove the center console trim panel.

2004 X-TYPE - Instrument Panel and Console - 501-12

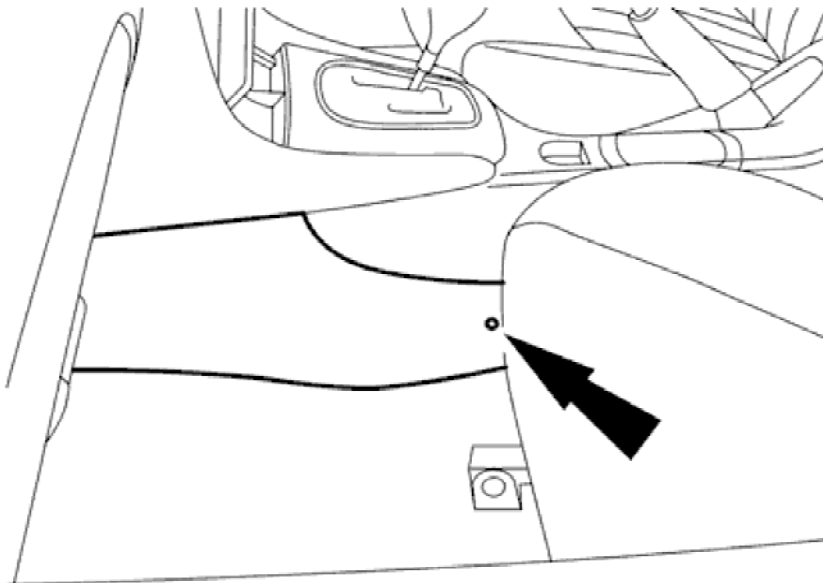

VUJ0004220

7. Remove the center console trim panel.

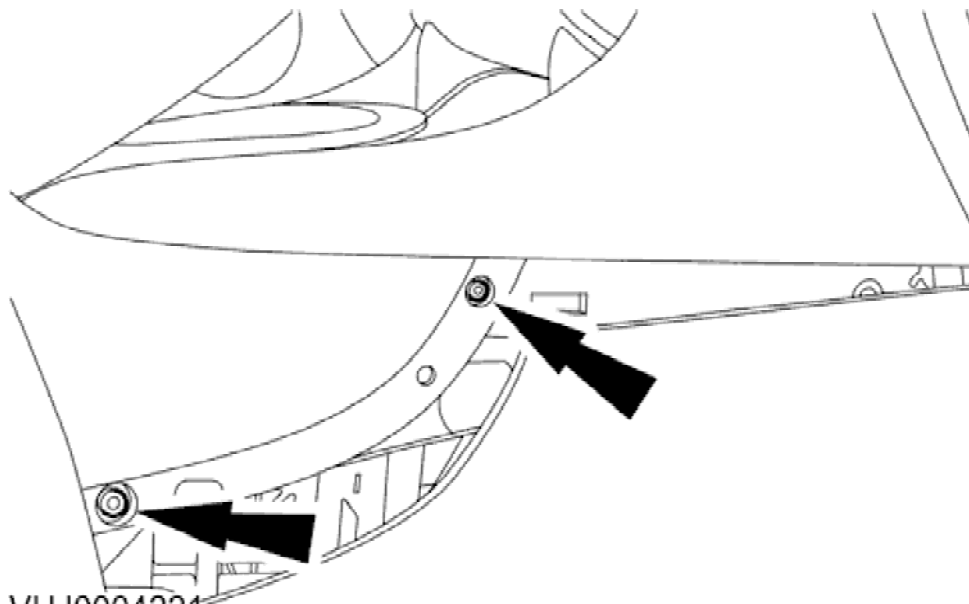

VUJ0004221

8. **NOTE:**

Right hand shown, left hand similar.

Remove the retaining screws.

Vehicles with automatic transmission

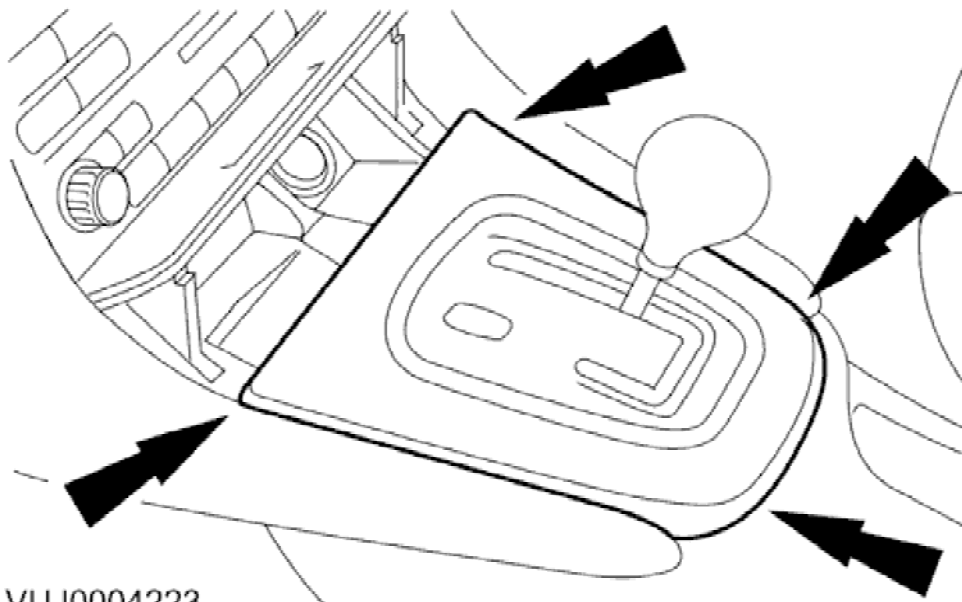

VUJ0004223

9. Remove the J-gate surround.

Vehicles with manual transmission

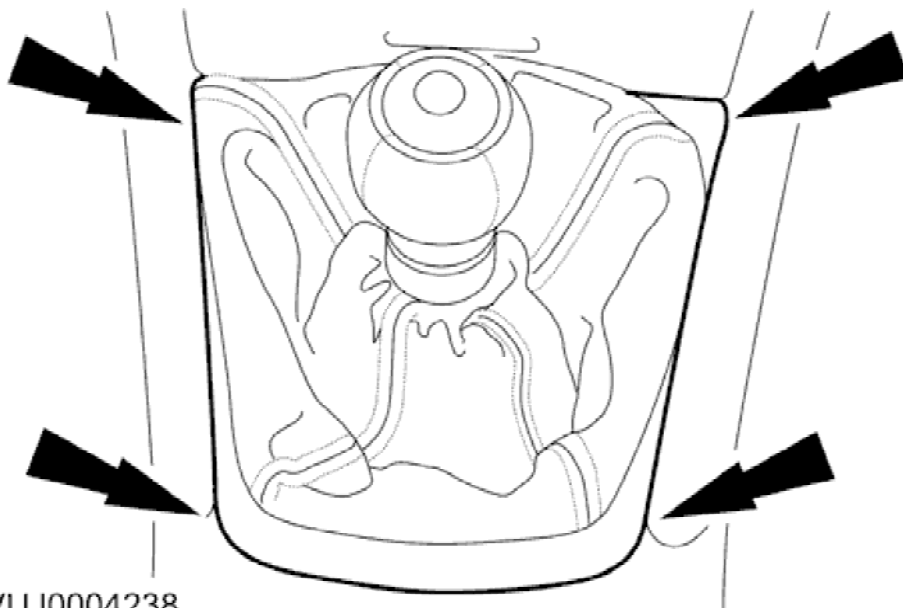

VUJ0004238

10. Detach the gear selector surround.

All vehicles

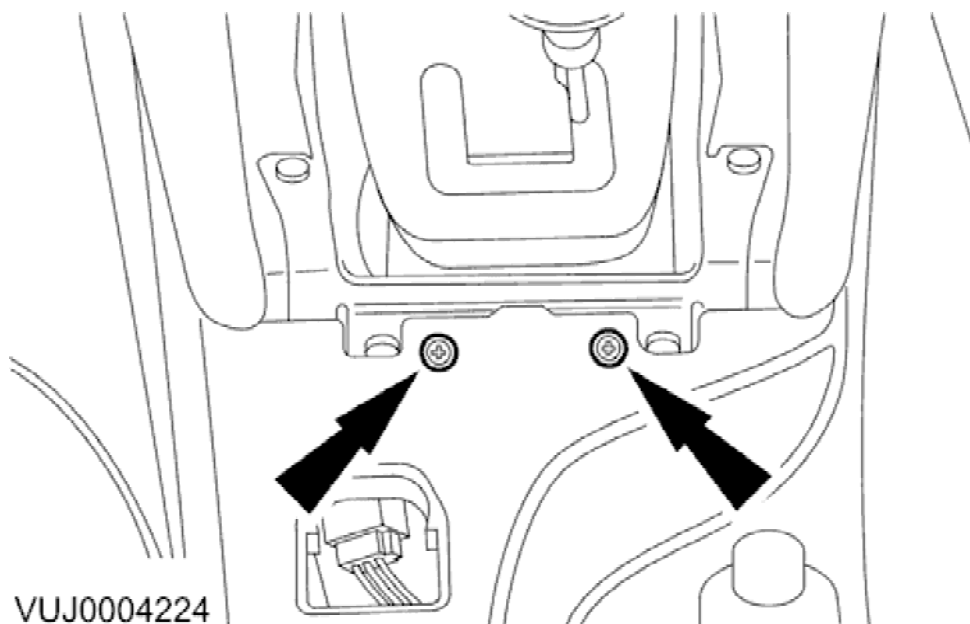

VUJ0004224

11. Remove the retaining screws.

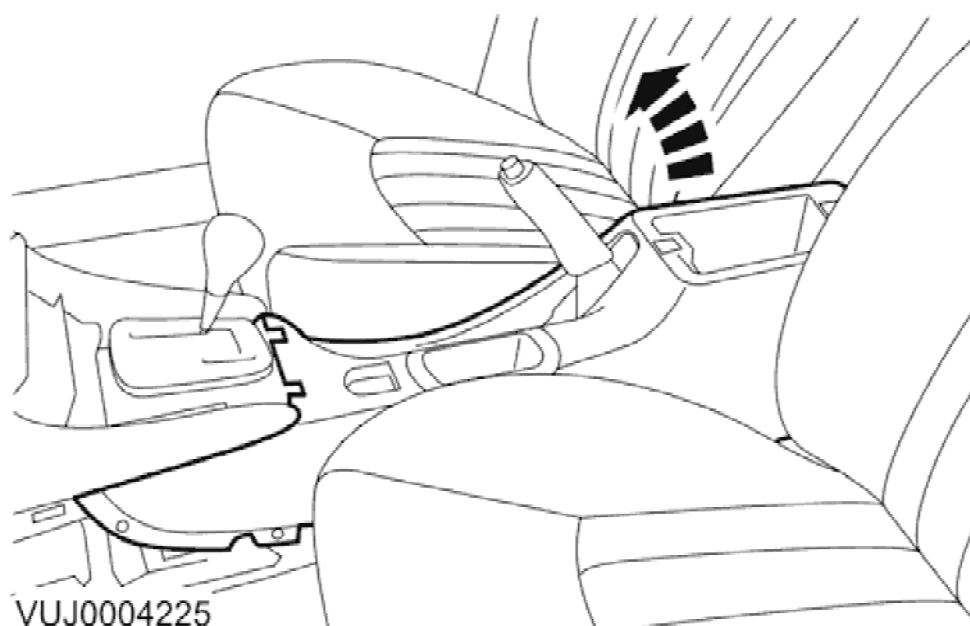

VUJ0004225

12. Remove the console.

Installation

1. To install, reverse the removal procedure.