

CLEAR COAT IDENTIFICATION

All colors are clear coat.

INFORMATION LABELS

Label, A/C	C2C006249	21.05
Label, Emission w/Supercharger	XR8042719	4.50
w/o Supercharger	XR8035720	2.25
Label, Emission Hose Routing w/Supercharger	04 C2C024771	1.50
05 XR8051921	1.55	
w/o Supercharger	04 C2C024770	1.40
05 XR8051820	1.50	
XR8047031	1.40	
Label, Fan Warning		
Label, Headlamp Caution w/Navigation System w/DVD Player	C2C010228	2.45
w/o DVD Player	XR8034564	6.70
w/o Navigation System	C2C009628	1.95
Label, Pass Air Bag Upper	GNA2620CA	5.45
Lower	GNA2621CA	d2.45
Label, Side Air Bag	R/L C2C014610	4.50
Label, Tire	C2C002284	2.20
Label, Unleaded Fuel	C2C018300	1.35

FRONT BUMPER

Use Procedure Explanations 1 and 28 with the following text.

Refinish Front Cover	2.6
Refinish Impact Bar	1.0
Refinish Parking Aid Sensor	.3
Refinish Sensor Cover	.2
R&I Bumper Assy	#1.6
O/H Bumper Assy (Includes R&I)	#2.2
#Includes R&I Grille Assy	
R&R Parking Sensors Complete	.4
Add to R&R or O/H Front Bumper w/Parking Aid	.3
w/ H/Lamp Washers	.3

NOTE: All Parts in this section are included in overhaul unless noted otherwise.

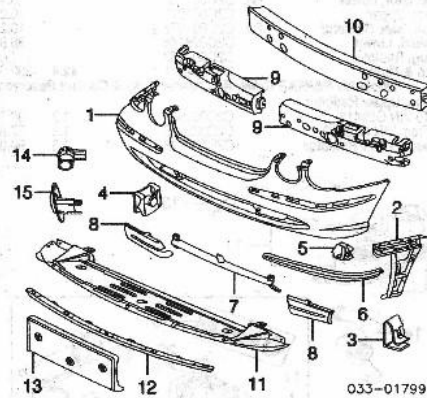

033-01799

1 Cover, Front (P) w/Parking Aid		
w/ H/Lamp Washer	C2C020193XXX	#2.2 940.00
w/o H/Lamp Washer	C2C020191XXX	#2.2 955.00
w/o Parking Aid		
w/ H/Lamp Washer	C2C006217XXX	#2.2 775.00
w/o H/Lamp Washer	C2C020192XXX	#2.2 950.00
(P) Paint to Match		
#Includes R&I Grille Assy		
2 Bracket, Front Cover	R C2C004652	53.65
L C2C004653	42.50	
3 Support, Front Cover (2/Side)	R/L C2S011341	2.20
4 Nut, Spring (4)	C2S002151	1.15
5 Washer, Cover (6)	XR8002175	1.90
6 Moulding, Cover	R C2C001592	3 148.75
L C2C001593	3 150.75	
7 Deflector, Inner Air	C2C001521	151.20
8 Insert, Lower Cover	R/L C2C004656-7	29.05
9 Absorber, Impact	R C2C001602	92.85
L C2C001606	92.85	
10 Bar, Impact (P) (P) Paint to Match	C2C003296	#.5 334.00
#w/Bumper Cover Removed, Not Included in O/H		
11 Panel, Valance	C2C009223	.4 525.00
12 Deflector, Lower	C2C009540	.3 57.95
13 Bracket, License	C2C001522	.2 22.85
14 Sensor, Parking Aid (P) Outer	R/L C2C021644XXX	#.2 89.20
Inner	R/L C2C021643XXX	#.2 89.20
15 Cover, Sensor (P) Outer	R C2C007497XXX	#.2 6.15
L C2C007500XXX	#.2 6.15	
Inner	R C2C007499XXX	#.2 6.15

(P) Paint to Match L C2C007498XXX #.2 6.15
#R&R Complete, w/Front Cover Removed

GRILLE

Refinish Grille Bezel	.5
R&I Grille Assy	#.3
#Included in R&R/R&R or O/H Front Cover	

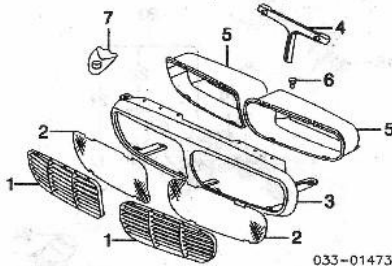

033-01473

Grille		
1 XJB, XJBL, Vanden Plas Chrome	R C2C011798	#.2 72.25
L C2C011800	#.2 72.25	
Gray	R/L C2C011746-7	#.2 54.70
2 XJR, XJ Super #R&R One Side Complete	R/L C2C011804-5	#.2 276.00
3 Bezel, Grille Chrome	C2C018703	#.5 400.00
Paint to Match	C2C011748XXX	#.5 590.00
4 Reinforcement, Grille Opening	C2C018702	15.05
5 Housing, Grille #R&R Complete, Includes R&R Grilles	R/L C2C011801-2	#.5 11.65
6 Retainer, Housing (8)	C2C011803	2.75
7 Emblem To VIN G34526	C2C025678	.2 31.80
From VIN G34327	C2C025678	.2 31.80

FRONT LAMPS

COMBINATION LAMP HALOGEN

Aim Lamps	.4
R&I Combination Lamp	R/L #.3
#w/Front Cover Removed	

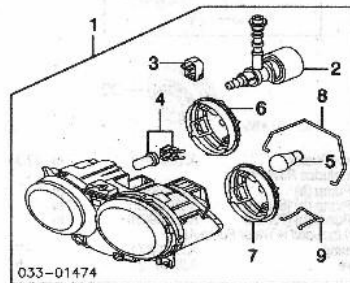

033-01474

1 Lamp Assy, Combination	R C2C022619	#.3 449.00
L C2C022626	#.3 449.00	
#w/Front Cover Removed		
2 Motor, Stepper	R/L C2C007783	117.30
3 Vent, Lamp	R/L C2C009067	0.00
4 Bulb, Headlamp (2/Side)	R/L LNC51805A	#.2 9.80
5 Bulb, Signal	R/L C2S015076	#.2 10.55
#R&R One Side Complete		
Cover, Bulb		
6 Inner	R/L C2C009070	2.75
7 Outer	R/L C2C009089	11.40
8 Clip, Cover Retaining	R/L C2C009066	d.70
9 Inner	R/L C2C009072	d.70
#Included w/Combination Lamp Assy		

COMBINATION LAMP XENON

Aim Lamps	.4
R&I Combination Lamp	R/L #.3
#w/Front Cover Removed	

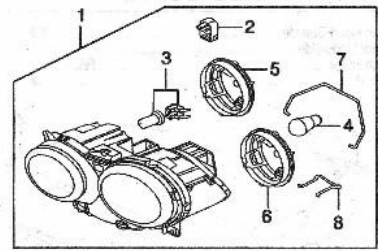

033-01475

1 Lamp Assy, Combination To VIN G15432	R C2C022624	#.3 915.00
L C2C022631	#.3 915.00	
From VIN G15433 to VIN G18947	R C2C022624	#.3 915.00
L C2C022631	#.3 915.00	
From VIN G18248	R C2C022624	#.3 915.00
L C2C022631	#.3 915.00	
#w/Front Cover Removed		
2 Vent, Lamp	R/L C2C009067	0.00
3 Bulb, Headlamp (2/Side)	R/L C2N001716	#.2 122.45
4 Bulb, Signal	R/L C2S015076	#.2 10.55
#R&R One Side Complete		
Cover, Bulb		
5 Inner	R/L C2C009070	2.75
6 Outer (2/Side)	R/L C2C009069	11.40
7 Clip, Cover Retaining	R/L C2C009066	d.70
8 Outer	R/L C2C009072	d.70
#Included w/Combination Lamp Assy		
9 Control, Xenon Bulb	R/L N.A.	0.00

SIDE MARKER LAMP

R&I Side Marker Lamp	R/L #.2
#Included in R&R or O/H Front Bumper	

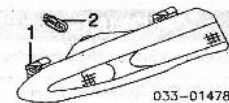

033-01478

1 Lamp, Side Marker	R C2C002051	#.2 25.80
L C2C010423	#.2 22.25	
#Included in R&R or O/H Front Bumper		
2 Bulb, Side Marker	R/L C2S015074	.2 .75

SIDE REPEATER LAMP

R&I Side Repeater Lamp	R/L #.2
#Included in R&R Fender	

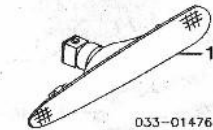

033-01476

1 Lamp, Side Repeater	R/L C2C002046-7	#.2 90.75
#Included in R&R Fender		

FOG LAMP

R&I Fog Lamp	R/L #.3
#Included in R&R or O/H Front Bumper	

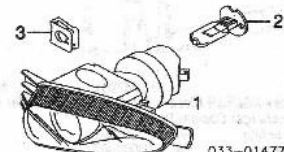

033-01477

1 Lamp, Fog	R/L XR8007608-9	#.3 115.95
#Included in R&R or O/H Front Bumper		
2 Bulb, Fog Lamp	R/L DBC011408	.2 16.05
3 Nut, Fog Lamp Mtg	R/L XR8007652	2.45
#As Required		

HOOD

Use Procedure Explanations 4 and 28 with the following text.