



Your best partner for better driving

Install Manual

(GVIF08 V7.2)

QDIS

Warning / Caution



Warning

- When installing the main unit, do not remove or alter existing vehicle fasteners, including nuts, bolts, screw, clips, and fittings. Never detach, move or alter existing vehicle wiring, including electrical grounds and straps. Alteration of existing vehicle components may make vehicle unsafe to operate. Should be no any electronic devices or magnetic pole around installation place.
- Air bags are vital part of a safety system. Never install main unit in a way which will alter air bag wiring or interfere with air bag deployment. Air bags must function properly in the event of an accident.
- Before installing, check the location of pipe, tank, electrical cables and others.
- Read and follow the instruction manual.
- Wiring location must not interfere driving, get in or out from car.
- Use electrical tape to insulate the ends of all wires, even if they are not used. Proper insulation prevents arcs, shocks and fires.
- When installation is complete, test all vehicle electrical systems to ensure they operate correctly, including lights, horn, brake lights, and emergency flashers.
- According to our sales policy, any problems caused by user's mistake, careless can not be guaranteed.



Caution

- All steps of installation should be done by well-trained specialist.
- During installation ignition key should be taken off and after all installation finish connect power cable with interface for the last step.
- Do not install the main unit in places where it ma be exposed to dew condensation (around the air conditioning hose, etc), or in locations where it may come in contact with water, high levels of moisture, dust or oily smoke
- Install wiring in a manner in which cables will not come in contact with metal parts. The wiring may be damaged by contact with metal parts, resulting in fire and shocks. Avoid all contact with hot surfaces when wiring the main unit. High temperatures may damage wiring, causing shorts, arcing and fires.
- Kindly check all parts are in the box, when receiving the product, if anything missing, inform to the supplier or manufacturer.

Table of Contents

1. Specifications	
1.1 Main Specifications-----	4
1.2 Features-----	5
1.3 System Diagram-----	6
1.4 Components-----	7
1.5 Exterior -----	8
2. Installation	
2.1 Installation Diagram-----	9
2.2 Installation-----	10
2.3 Connecting Can wires	
3. Settings	
3.1 DIP Switch -----	13
3.2 Remote Control -----	14
3.3 OSD -----	15
3.4 Factory Mode -----	16
3.5 Rear Parking Guidelines -----	17
4. Trouble Shooting -----	18

1. Specifications

1.1 Main Specifications

1. Input Spec. (MULTI VIDEO INTERFACE)
 - 3 x A/V Input (External video source).
 - 1 x CVBS(REAR CAMERA) Input. (Rear camera source)
 - 1 x Analog RGB Input (Navigation System output)
 - 1 x LCD Input (Car system Input)
 - 1 x GVIF Input

2. Output Spec.
 - 1 x GVIF Output
 - 4 x Audio Select (12V power comes out from 4wires of cable by video, Navi mode)

3. Power Spec.
 - Input Power : 8VDC ~ 18VDC
 - Consumption Power : 6WATT, Max

4. Switch Input mode
 - Input Video MUTE Function : Possible to make each input mute by operating Dip S/W.
 - Possible to switch Input mode with switch for source toggle
 - Possible to switch mode through CAN

1. Specifications

1.2 Features

- Upgraded resolution
- Compatible with NTSC, PAL (Except Lexus)
- Able to use OEM button in A/V and Navi mode by Adding Navi SEL
- Easy to control with a remote control
- Able to adjust DVD, NAVI display on screen
- Able to operate OSD menu without video input

1. Specification

1.3 System Diagram

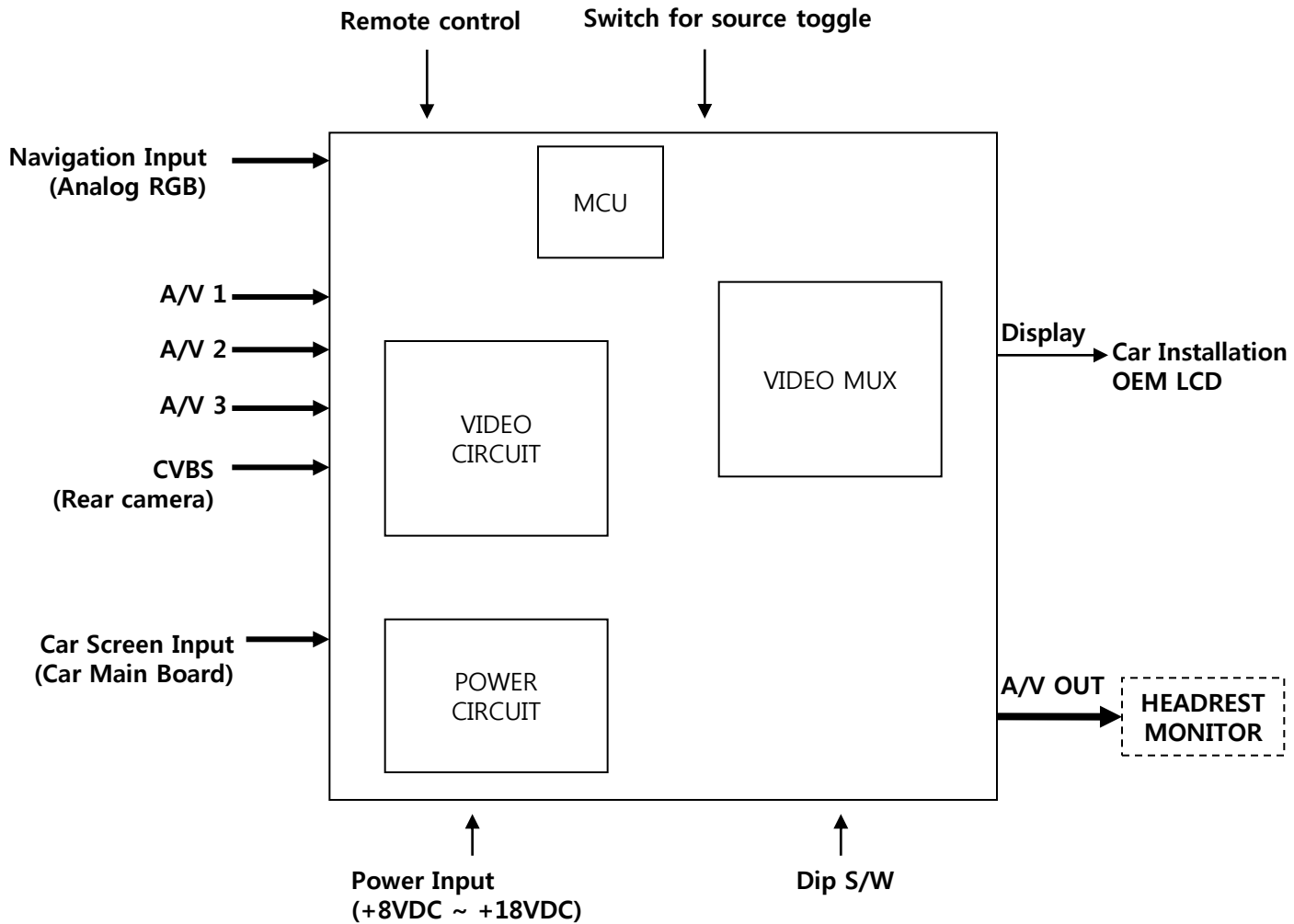

1. Specification

1.4 Components



Remote control * 1ea
(REMOTE0001)



TOUCH OUT cable * 1ea
(HTOUCH0004)

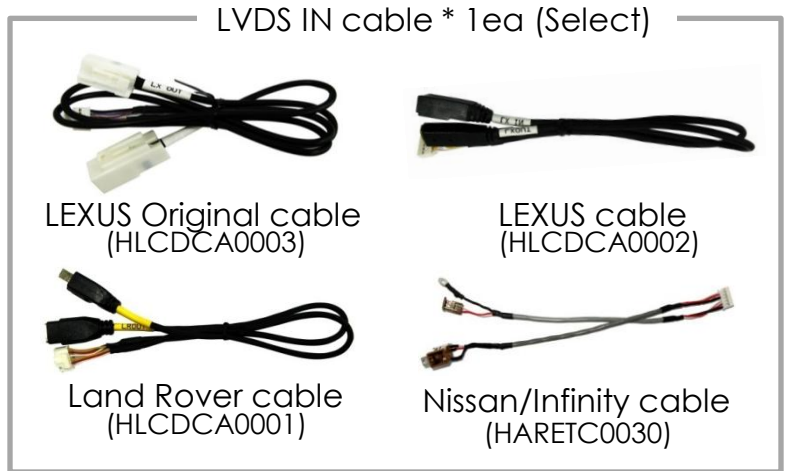

LVDS IN cable * 1ea (Select)

LEXUS Original cable
(HLCDCA0003)

LEXUS cable
(HLCDCA0002)

Land Rover cable
(HLCDCA0001)

Nissan/Infinity cable
(HARETC0030)

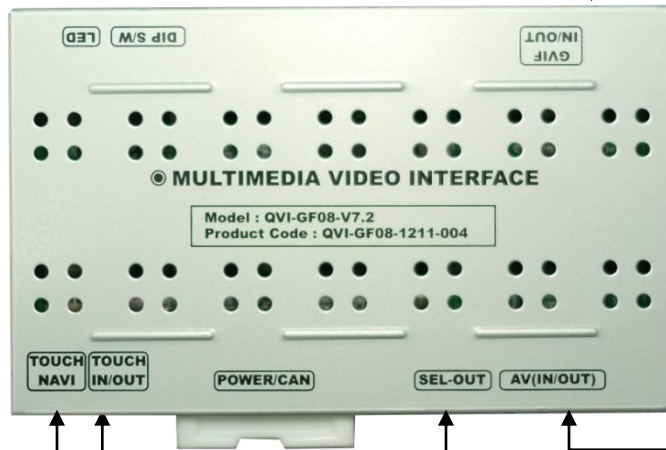

AV cable * 1ea
(HAVCAB0002)



TOUCH cable * 1ea
(HTOUCH0016)



4P FFC cable * 1ea



TOUCH cable * 1ea
(HTOUCH0017)



8P FFC cable * 1ea

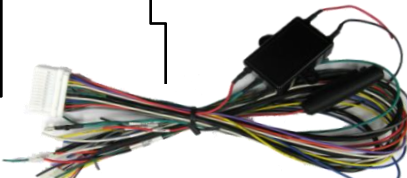

POWER cable (24P) * 1ea
(HPOWER0011)



SEL cable * 1ea
(HSELCA0001)

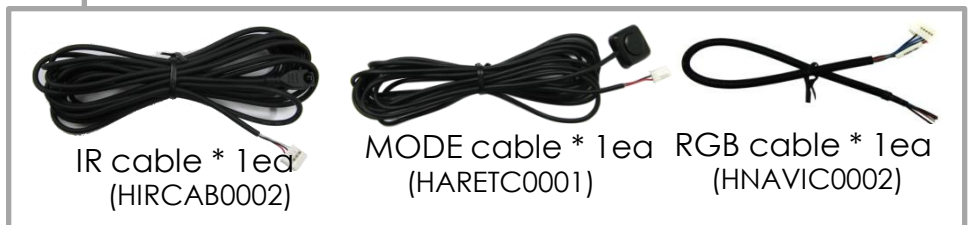

IR cable * 1ea
(HIRCAB0002)

MODE cable * 1ea
(HARETC0001)

RGB cable * 1ea
(HNAVIC0002)

* Select 4pin or 8pin as per touch screen.

1. Specifications

1.5 Exterior

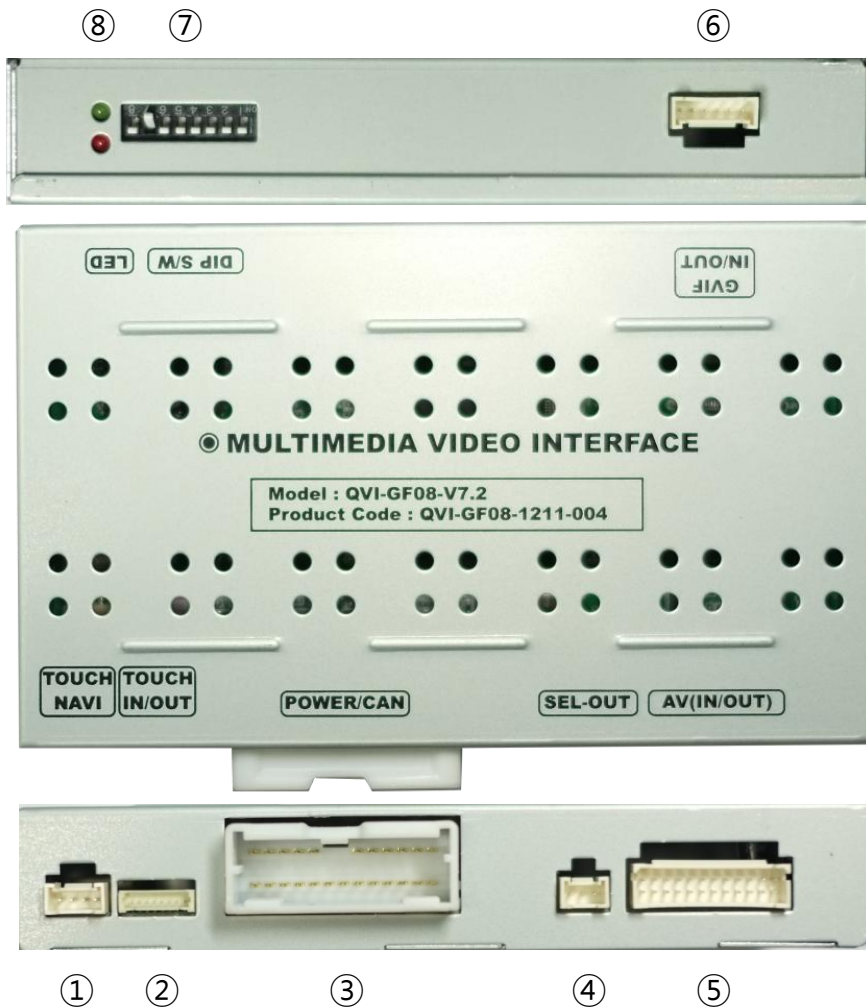

Dimension

Width 139mm
Length 87mm
Height 24mm

- ① TOUCH NAVI
- ② TOUCH IN/OUT
- ③ POWER/CAN
- ④ SEL-OUT
- ⑤ AV(IN/OUT)
- ⑥ GVIF IN/OUT
- ⑦ DIP S/W
- ⑧ LED

2. Installation

2.1 Installation Diagram

※Connect I/F CAN High(Green + Brown) with CAR CAN(Green + Orange)

※Connect I/F CAN Low(Green) with CAR CAN(Green)

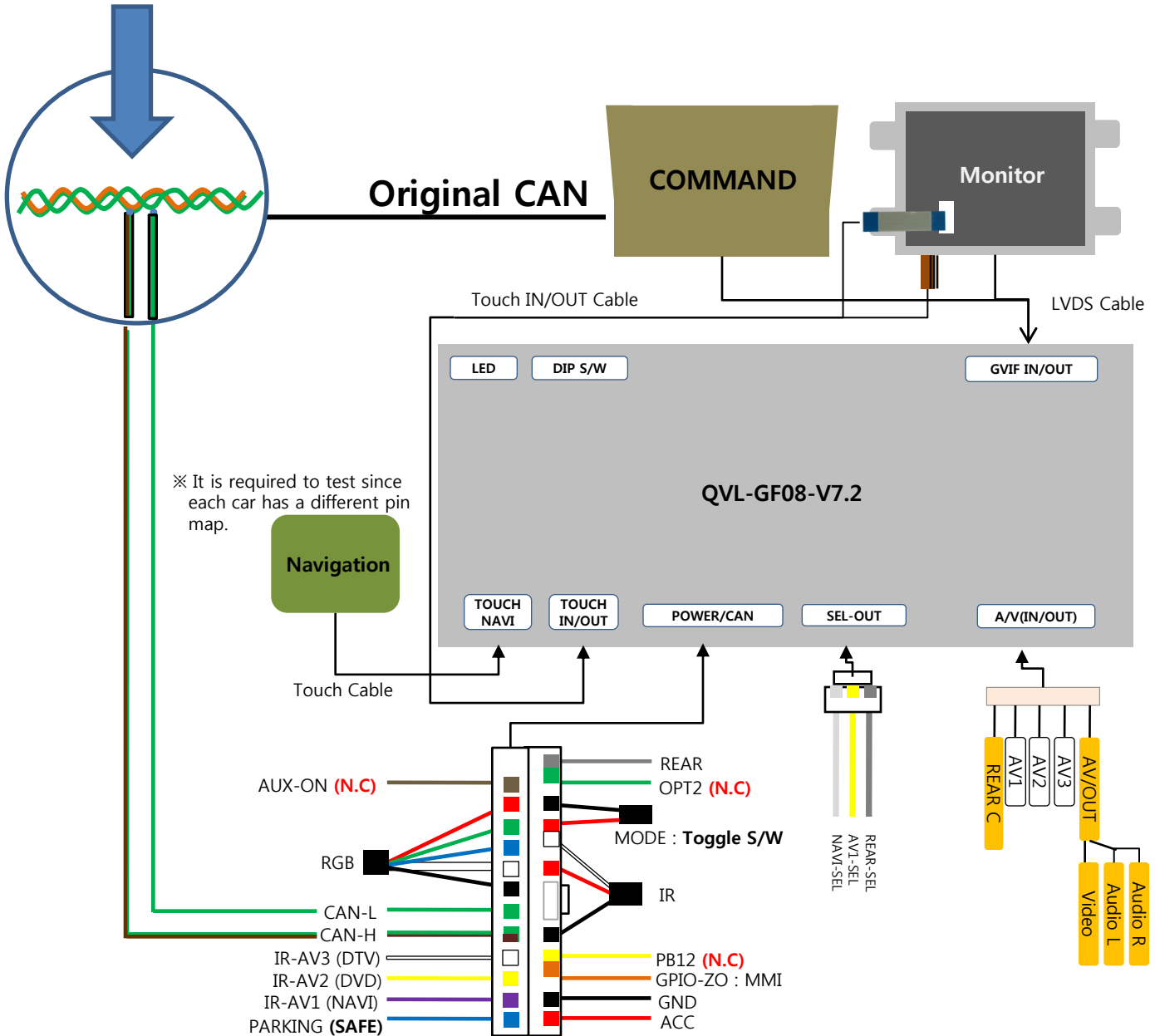

2. Installation

2.2 Installation

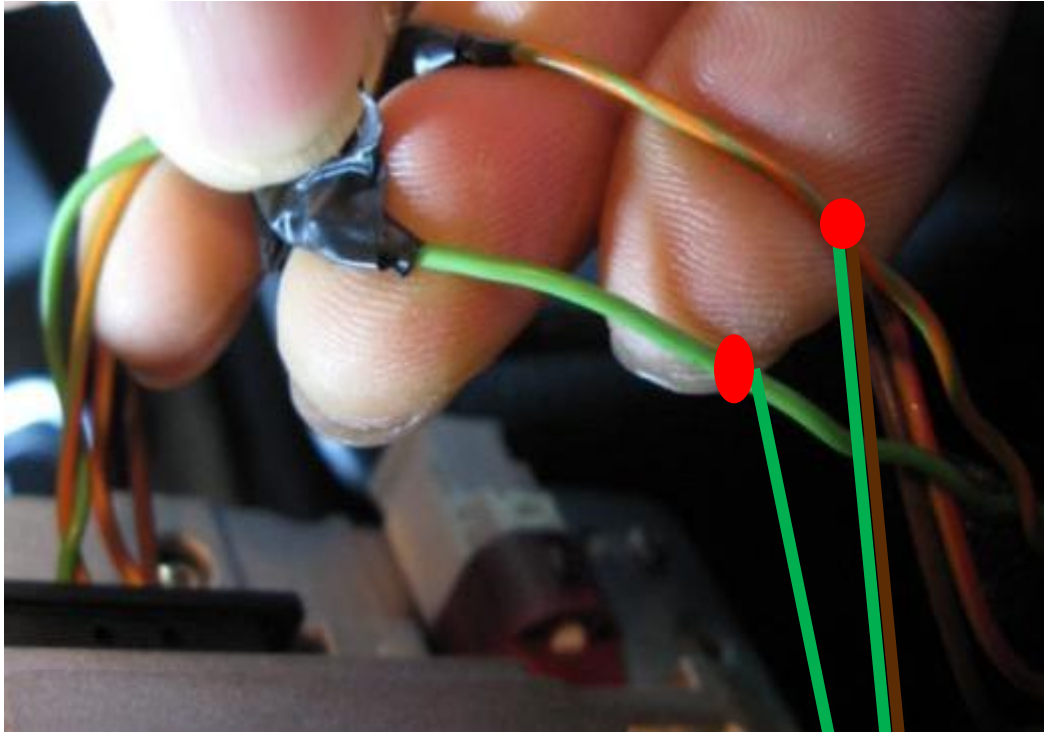

CAN-Low

CAN-High

POWER CABLE

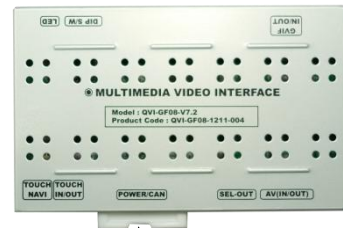

※ The photo as above,

- Connect Interface CAN High(Green+Brown) with Car CAN(Green+Orange)
- Connect Interface CAN Low(Green) with Car CAN(Green).

2. Installation

2.2 Installation(Lexus IS250, IS300 2014)

※ Connecting cables for Lexus

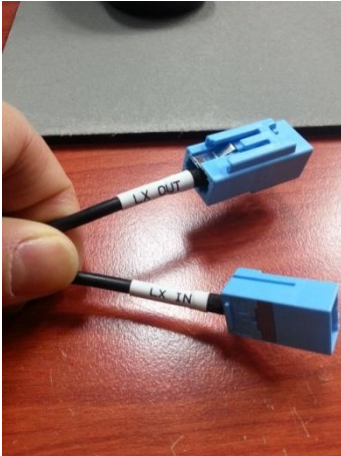

-
- Connect LX OUT of the Lexus original cable provided by Qdis with the cable separated from Monitor.
 - Connect LX IN with Monitor

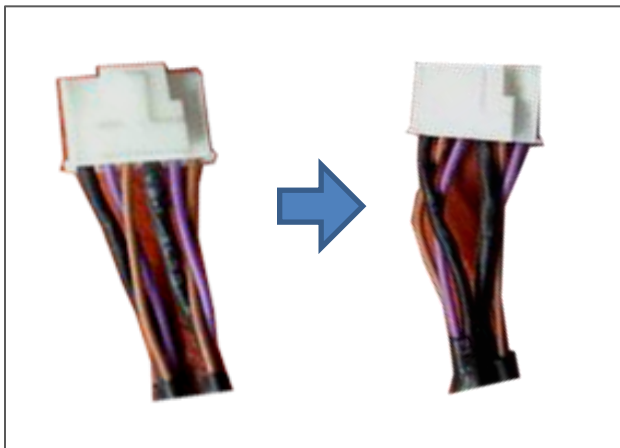

※ Change the pin assignment of the LEXUS original cable as above photo.

2. Installation

2.2 Installation (Lexus IS250, IS300 2014)

※ Connecting Relay Board(Only use when screen is blicking)



※ First, Find the OEM Connector under Dash board.

Second, Cut the marked point and connect cables.

Third, Connect Navi-Sel cable of Qdis SEL with Relay board.

3. Setting

3.1 DIP Switch

※ ON : DOWN, OFF : UP
 ※ Example DIP S/W usage



※ ON : DOWN, OFF : UP

[LEXUS]

- Input mode : MAIN + A/V3
- Rear Camera : INSTALL CVBS4

- ▷ DIP S/W : 1,2,3 → ON (INPUT MODE SKIP)
- ▷ DIP S/W : 4 → OFF (A/V3 USEABLE)
- ▷ DIP S/W : 5 → ON
- ▷ DIP S/W : 6 → OFF
- ▷ DIP S/W : 7 → ON (CVBS4 USEABLE)
- ▷ DIP S/W : 8 → OFF

#PIN	기능	DIP S/W 선택
1	RGB INPUT MUTE	ON : Skipping RGB Mode OFF : RGB Display
2	A/V 1 MUTE	ON : Skipping A/V 1 OFF : A/V1 Display
3	A/V 2 MUTE	ON : Skipping A/V 2 OFF : A/V2 Display
4	A/V 3 MUTE	ON : Skipping A/V 3 OFF : A/V3 Display
5, 6	To select car model	Land rover : 5-OFF, 6-OFF Lexus : 5-ON, 6-OFF Lexus IS250, IS300, NX300H(2014~) : 5-OFF, 6-ON Buick : 5-ON, 6-OFF
7	Rear Mode	ON : External Rear Camera OFF : OEM Rear Camera
8		N.C

※ Please make sure to disconnect the power cable of the interface and reconnect the power cable again to apply the dip switch setting whenever changing DIP switch. Otherwise, DIP switch setting will not be applied.

3. Setting

3.2 Remote Control



<i>Key</i>	<i>Function</i>
POWER & PIP	No use
MENU	Activating OSD menu
OK	Making a selection, changing image display
▲	Moving upward
▼	Moving downward
◀	Moving leftward (If you press this button 2 seconds long, you can access the factory mode.)
▶	Moving rightward (If you press this button 2 seconds long, you can reset all the data about user environment.)

3. Setting

3.3 OSD (On Screen Display)

OSD Menu: Press "MENU" button to operate

Analog RGB 모드



Video 모드

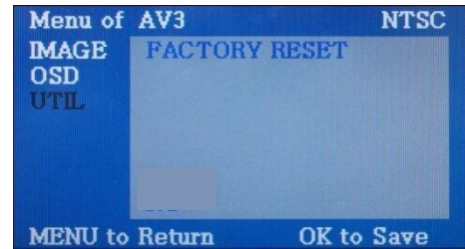
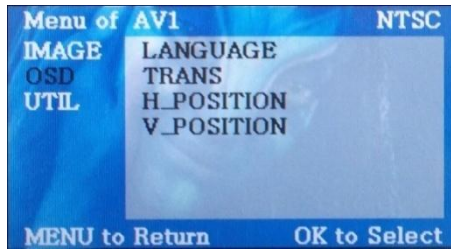
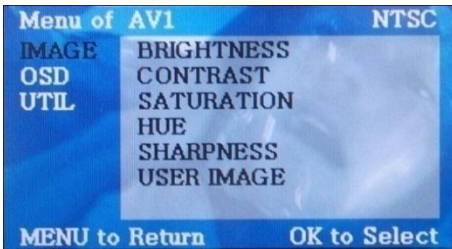

□ IMAGE

- BRIGHTNESS
- CONTRAST
- SATURATION
- HUE
- SHARPNESS :
- USER IMAGE : Selecting one among 4 color options.

□ OSD

- LANGUAGE : Choosing OSD language while using Touch OSD (English, Chinese only)
- TRANS : Adjusting transparency of OSD
- H_POSITION,
V_POSITION : Positioning OSD menu

□ UTIL

- FACTORY RESET : Resetting all the data about the relevant mode (applicable to navigation, DVD respectively)
Factory reset only for OSD function (unable reset video position)

3. Setting

3.4 FACTORY Mode

FACTORY mode – Press ◀ button 2 seconds long on the remote control.

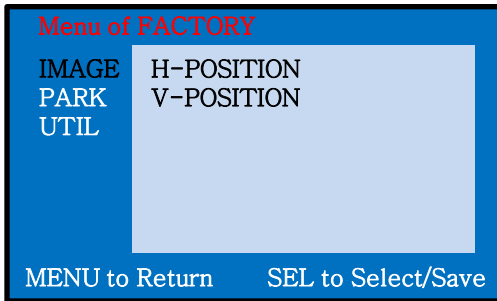

□ IMAGE

H-POSITION : Move display horizontally
V-POSITION : Move display vertically

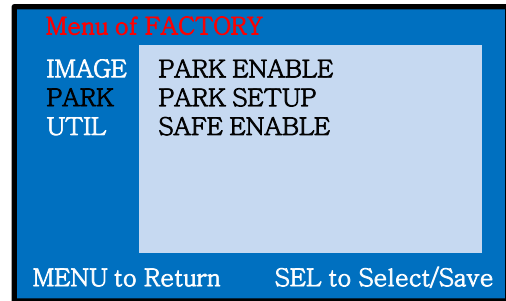

□ PARK

- PARK ENABLE : Set Rear Park Guide line
- PARK SETUP : Set position of rear parking guide line (Refer to Rear parking guide line)
- SAFE ENABLE : Select the use of Safe function while driving(Unable to use video while driving)

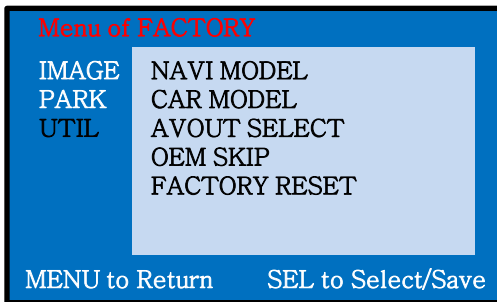

□ UTIL

- NAVI MODEL : Select Navigation Model
PANA RGB*, CARROZZERIA*, GN3000*, ICUBE*, GI8000N*, GI5000N*, KD900*, DELPHI*, MB7000*, WP9200, GI5000, A-CLASS, MYVI, HDMI
* No Use when Dip S/W #6 - ON
- CAR MODEL : Select Car model
- When Dip S/W #6 - OFF
DEFAULT : The cars before 2013 years
LEXUS-2013(L10) : 2010 year Lexus
LEXUS-2013 : Lexus after 2013 year
- When Dip S/W #6 – ON
DEFAULT : Lexus after 2014 year
NX300H : NX300H after 2014 year

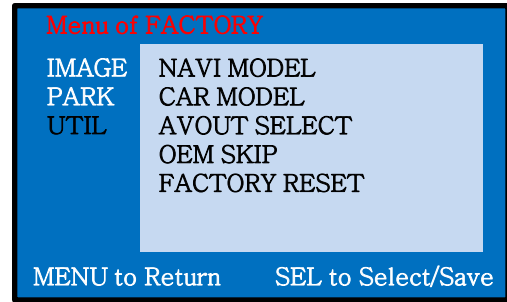

□ UTIL

- AVOUT SELECT : Selecting background sound After returning navigation or original mode
DEFAULT : Selecting AV sound just before changing navigation or original mode from the AV mode
AV 1~3 : Sound of the selected AV source 1~3
- OEM SKIP :
ON : SKIP OEM after booting
OFF : OEM display after booting
- FACTORY RESET : Reset

3.Setting

3.5 Rear parking guide line

FACTORY mode – Press ◀ button 2 seconds long on the remote control.

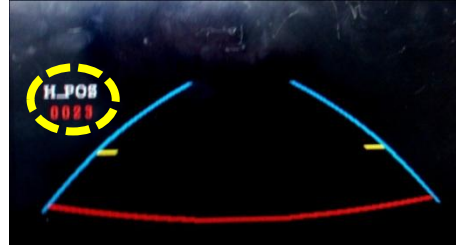
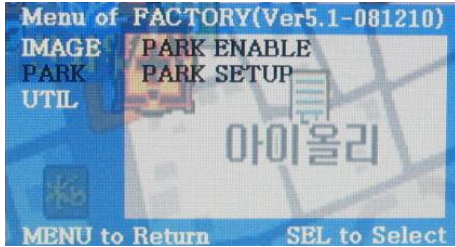

- ① photo as above, Select Park enable ON in Park mode (Initial Value – ON)

- ② Selecting Park Enable – ON, Parking guide line shall be shown on the screen after shifting into reverse gear. And then, Press OK button. H_POS shall be shown on the left side of the screen and you can control the direction of rear parking guide line(RIGHT/LEFT)

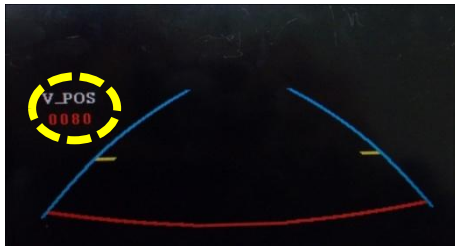

- ③ First, Control H_POS and Press OK button. Then, V_POS shall be shown on the left side of the screen. Now, You can control the direction of rear parking guide line(UP/DOWN)

4. Trouble Shooting

Q. I cannot change mode

- A. Check connection of Ground cable and IR Cable.
Check LED lamp is on, if not check connection of POWER cable.

Q. All I got on the screen is black.

- A. .Check second LED lamp of the interface is on, if not, check A/V sources connected are working well.
(Second lamp indicates AV sources connected works well.) Check interface connection has been done well.

Q. Displayed image color is not proper (too dark or unsuitable color)

- A. Try to select "INITIAL" in OSD menu, if it does not work, inform to manufacturer.

Q. I cannot watch the rear camera on the screen

- A. Set the DIP switch #7 as state "ON".

Q. Set mode not appear

- A. Check DIP Switch.

Q. OEM image is not displayed.

- A. Check interface's LCD In/Out cable connection. If the status keeps on, inform to manufacturer.

Q. Screen only displays white color.

- A. Check LCD out cable is connected well, if this status keeps, inform to manufacturer.

Q. External Video does not show up after connecting Lexus LVDS cable (HLCDCA0002)

- A. Try out Switching assignment of LVDS High(Red and Yellow) like (1↔2, 4↔5)
B. If it does not work, Please contact with the manufacturer.

Q. If External image is not shown and but OEM image works fine.

- A. Please swap the pin assignment of GVIF IN/OUT as follows, 123 <->456 and then swap purple cable with brown cable. after that please check if the image works fine.



RM #404 4TH FLOOR, B-DONG,
WOORIMLIONSVALLY, 371-28, GASAN-DONG,
GEUMCHEON-GU, SEOUL, KOREA.
TEL : 82-2-868-3627~9 | FAX : 82-2-2026-5987