

# Rear Door Trim Panel (76.34.04)

## Removal

### All vehicles

- 1 . Remove the rear door quarter window blind lower seal.

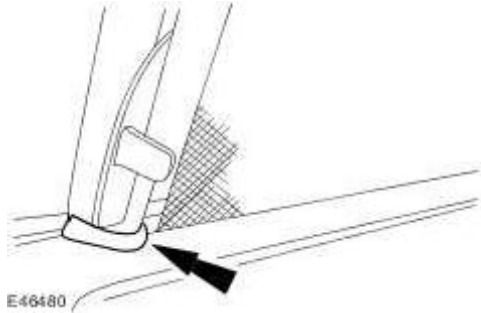

- 2 . Remove the rear door window blind finisher trim.

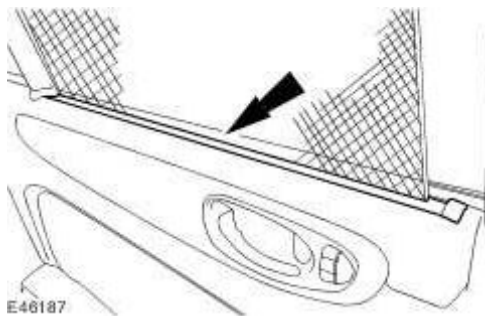

- 3 . Remove the rear door interior handle retaining screw cover.

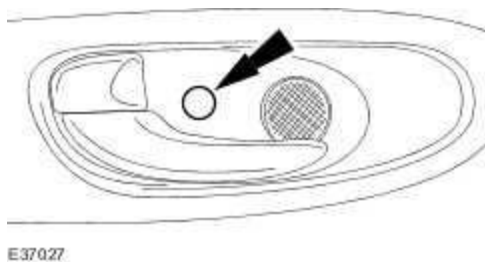

- 4 . Remove the rear door interior handle retaining screw.

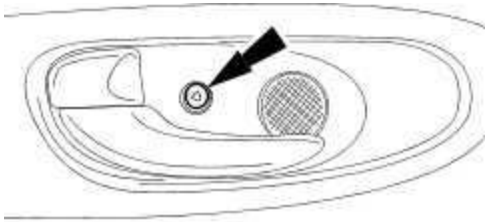

E37028

5 . Remove the rear door trim panel retaining screws.

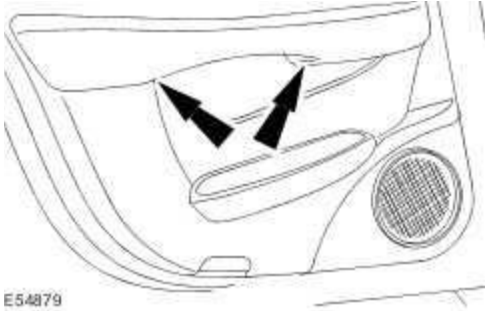

E54879

### Short wheelbase

6 . Remove the rear door trim panel retaining screw.

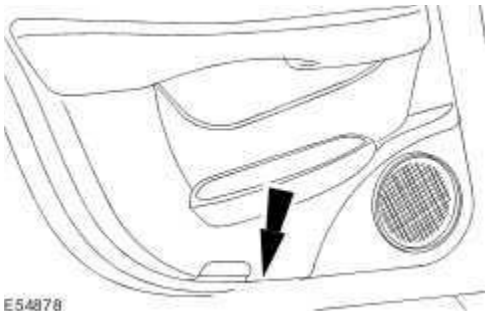

E54878

### Long wheelbase

7 . Remove the rear door trim panel retaining screws.

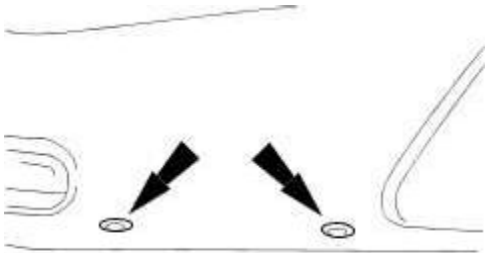

E53474

**All vehicles**

8 . Detach the rear door trim panel.

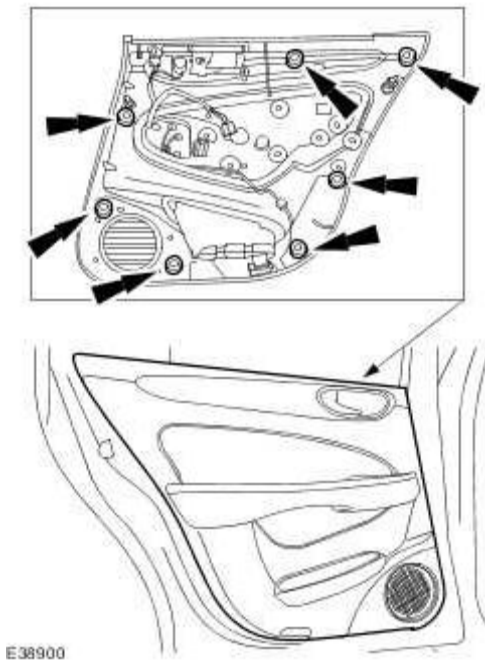

E38900

9 . Detach the rear door interior handle cable.

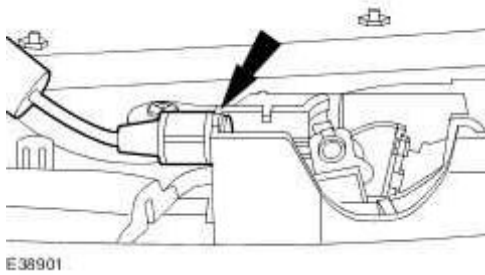

E38901

10 . Remove the rear door interior handle cable.

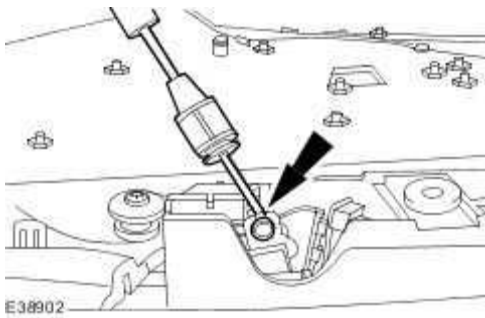

E38902

11 . Remove the rear door trim panel.

▶ Disconnect the electrical connector.

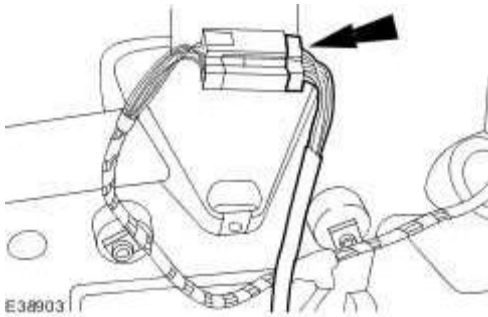

## Installation

1 . To install, reverse the removal procedure.