

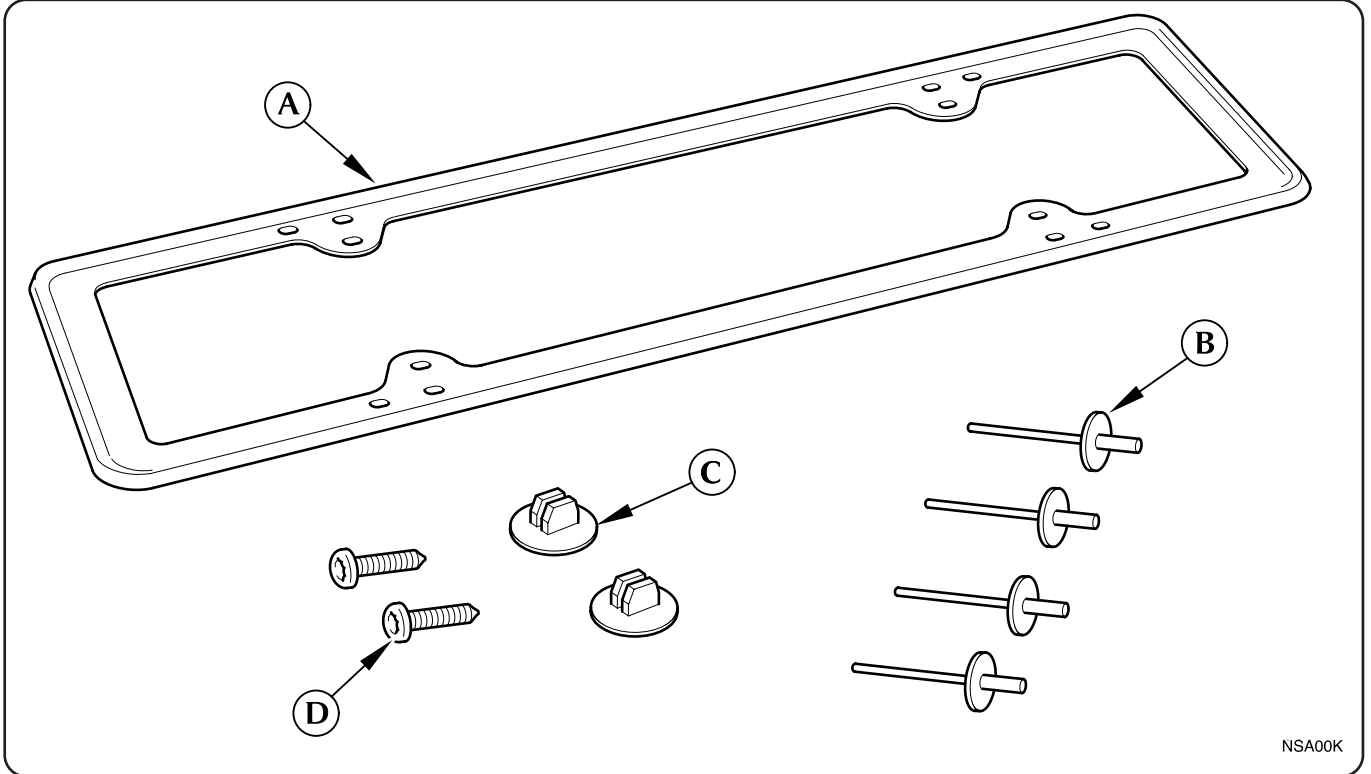

**FITTING INSTRUCTIONS, INSTRUCTIONS DE MONTAGE,  
EINBAUANLEITUNG, ISTRUZIONI DI MONTAGGIO,  
INSTRUCCIONES DE MONTAJE, 取扱説明書**

**XJ & XK Series,  
The XJ, La XJ,  
Der XJ, XJ**

**Rear Number Plate Surround, Entourage de plaque  
d'immatriculation arrière, Einfassung – Kennzeichen hinten,  
Marco de la placa de matrícula trasero, Cornice targa posteriore,  
リアナンバープレートサラウンド,**



**Content of kit**

- A. Number plate surround
- B. Pop rivets
- C. Retaining clips
- D. Screws

**Lieferumfang**

- A. Einfassung – Kennzeichen
- B. Blindniete
- C. Clips
- D. Schrauben

**Contenuto del kit**

- A. Cornice targa
- B. Rivetti ciechi
- C. Fermi
- D. Viti

**Contenu du kit**

- A. Entourage de plaque d'immatriculation
- B. Rivets aveugles
- C. Clips de fixation
- D. Vis

**Contenido del kit**

- A. Marco de la placa de matrícula
- B. Remaches ciegos
- C. Clips de sujeción
- D. Tornillos

**キット内容**

- A. ナンバープレートサラウンド
- B. ポップリベット
- C. リテーニングクリップ
- D. スクリュー

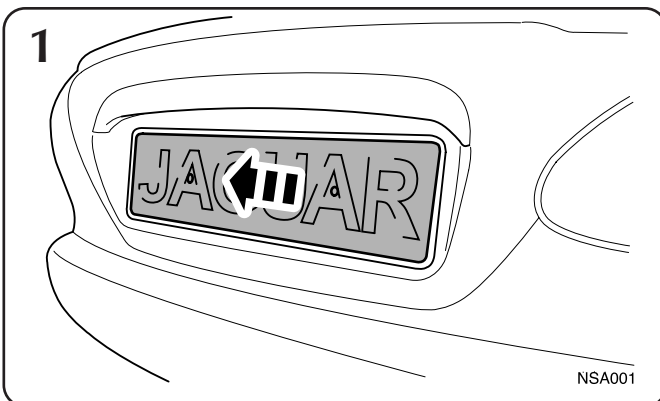

**MY 1998 →**

**Part No. XR8 28880**



**FITTING INSTRUCTIONS, INSTRUCTIONS DE MONTAGE,  
EINBAUANLEITUNG, ISTRUZIONI DI MONTAGGIO,  
INSTRUCCIONES DE MONTAJE, 取扱説明書**

**XJ & XK Series,  
The XJ, La XJ,  
Der XJ, XJ**

**Rear Number Plate Surround, Entourage de plaque  
d'immatriculation arrière, Einfassung – Kennzeichen hinten,  
Marco de la placa de matrícula trasero, Cornice targa posteriore,  
リアナンバープレートサラウンド,**

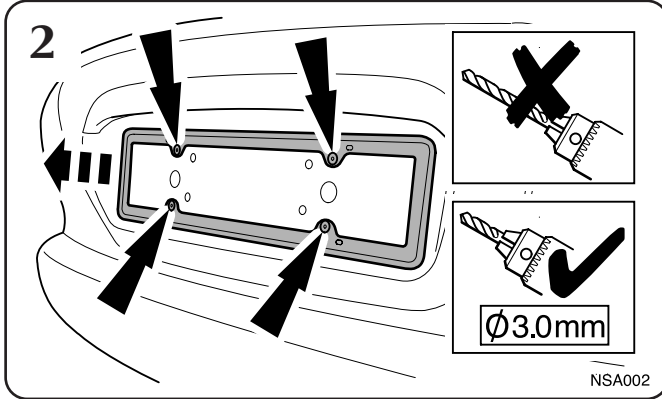

Notes: Hinweise: Note: Nota: 注:

- 2. XK Series, if fitted.
- 2. XK Series, le cas échéant.
- 2. XK Series, falls vorhanden.
- 2. XK Series, si procede.
- 2. XK Series, se in dotazione.
- 2. XK Series, 装着されている場合

Notes: Hinweise: Note: Nota: 注:

- 3a. XK Series.
- 3b. XJ Series.
- 3c. The XJ, La XJ, Der XJ, XJ.

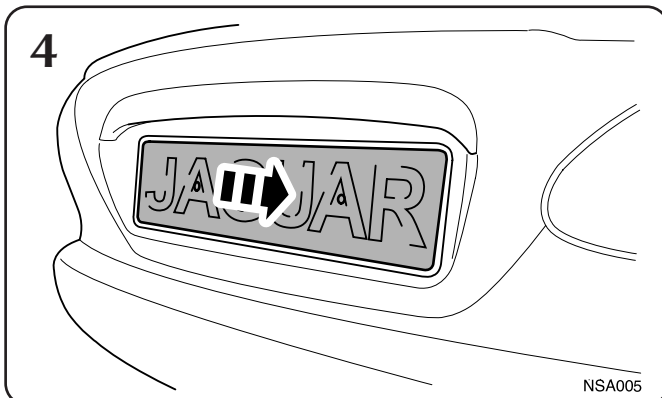
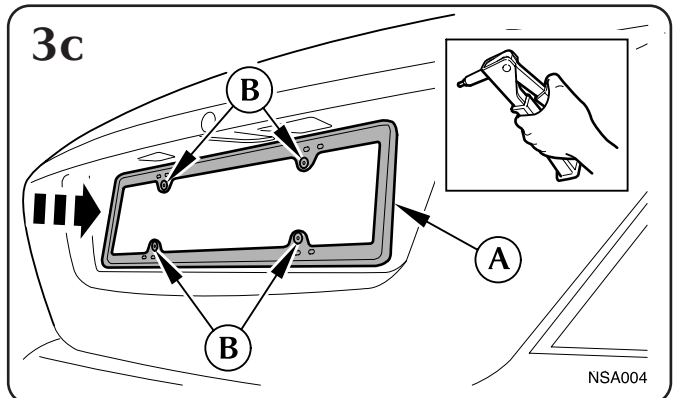
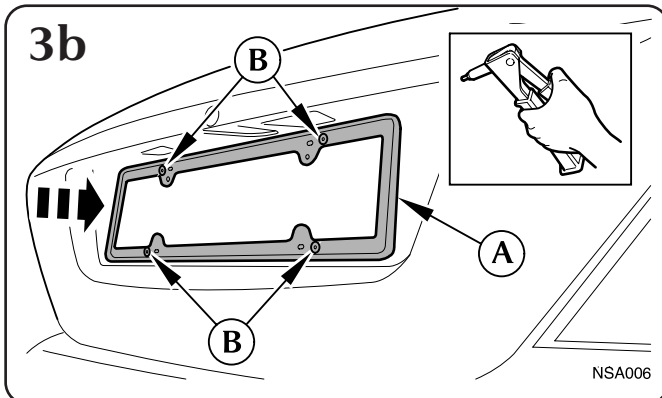
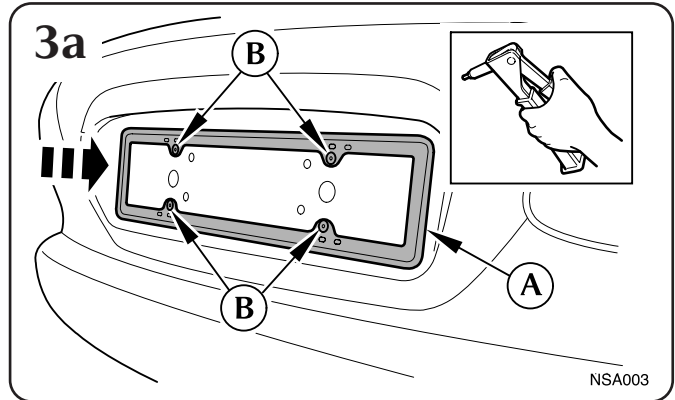

**MY 1998 ➔**

**Part No. XR8 28880**