

## 2010 XK tail lamps upgrade



## Installation instructions

**\*SAVE IN VECHILE FOR FURTURE REFERENCE\***

# Jaguar Wiring Color Codes

N or BN	Brown	O or OG	Orange
B or BK	Black	S or GY	Slate
W or WH	White	L	Light
K or PK	Pink	U or BU	Blue
G or GN	Green	P or VT	Purple
R or RD	Red	OPT	Fiber Optic
Y or YE	Yellow	SCR	Screen Braid

**\*READ THOROUGHLY BEFORE INSTALLATION\***

1. Remove trim panels in trunk: left and right side panels.

Scuff plate, Battery cover, Tire cover and Trunk lid cover.

2. Disconnect negative battery cable.

Note: You will lose your personal setting and window setting.

Read owner's manual for instructions' to reset windows, and seat modules.

Engine control module will reset with test drive approx. 10 miles.

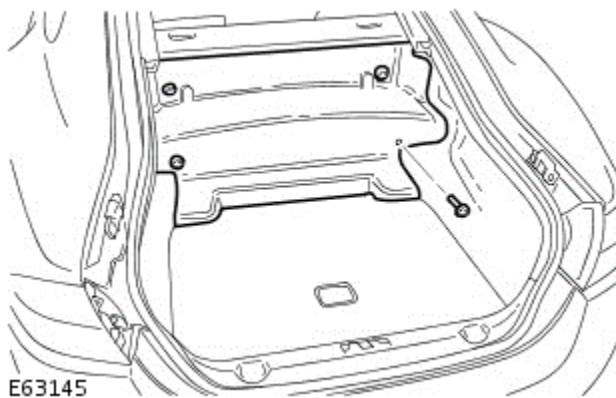

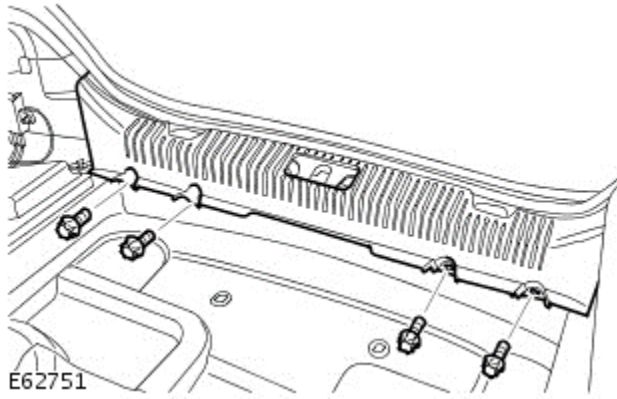

Scuff plate torx bolts remove.

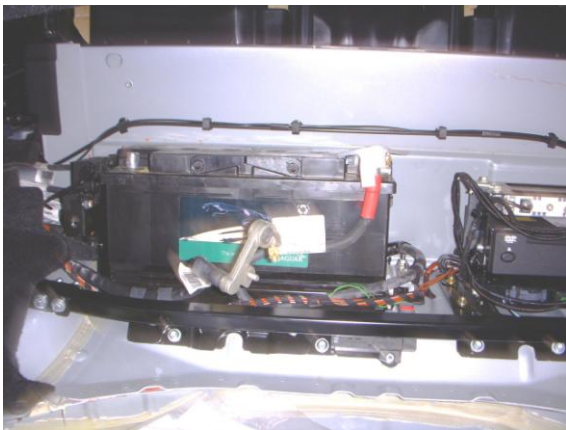

Negative battery terminal removed.



4. Trunk harness removal.

2010 trunk harness (top)

2007 trunk harness (lower)



Note: location of harness clips. Remove License plate lights.



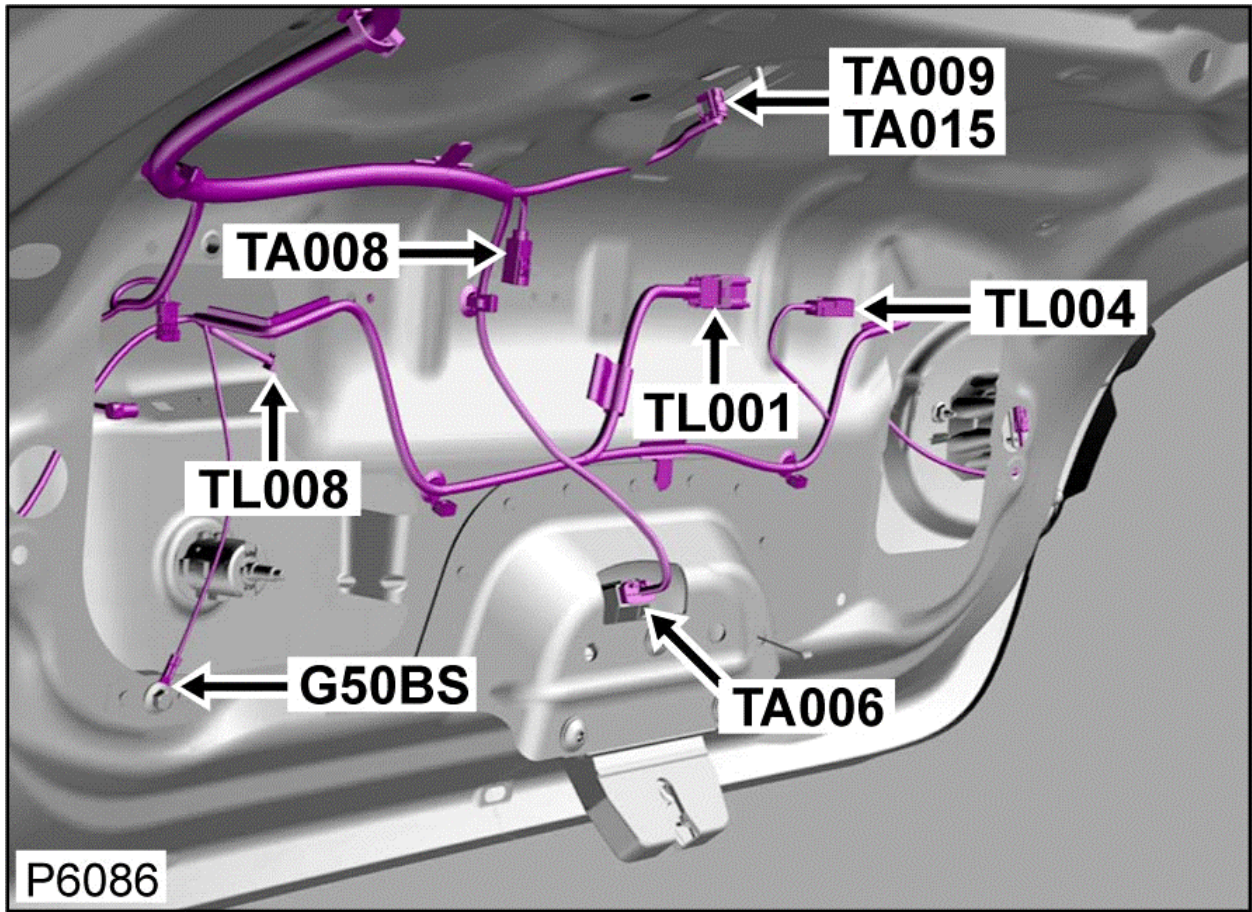

Remove 3 nuts for the light, disconnect connector.

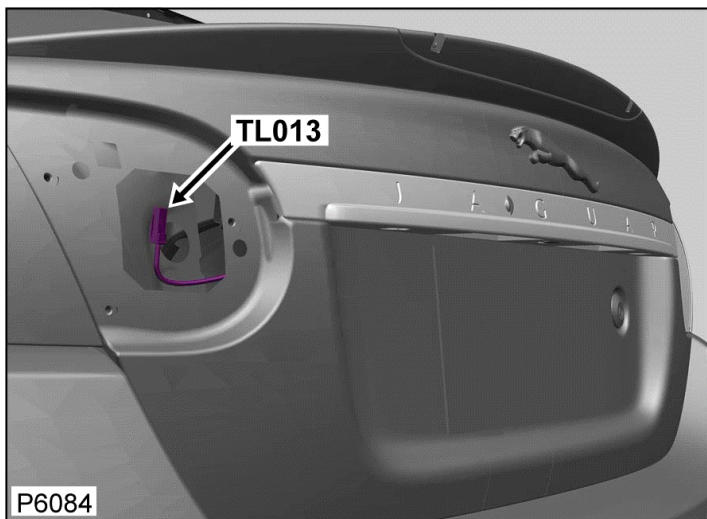

2010 green \_\_\_\_\_ 2007 black connector.

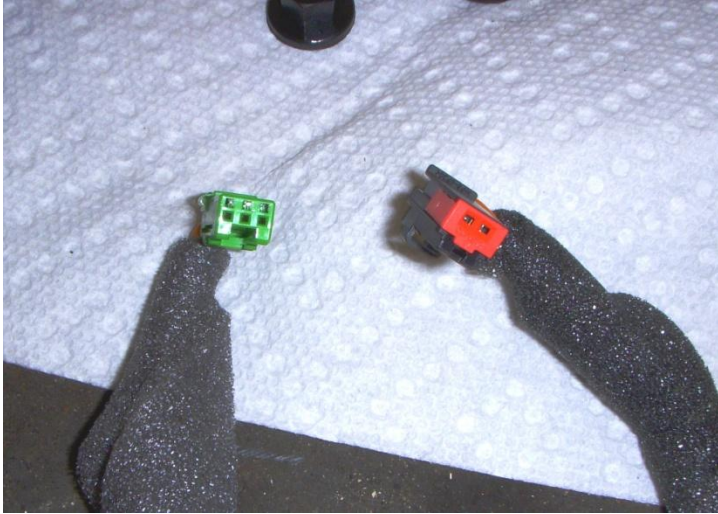

5. Install 2010 trunk harness.

6. Connect green connector to fog/rev lights and install lamps.

7. Check all connectors to see if they are fasten properly.

8. Connect negative battery terminal.

9. Test rear fog lamps and license plate lamps.

Turn on the ignition and lights push rear fog light switch.

Observe the fog lamps. Is it on?

If reverse lights is on. The fog and reverse wires need to be switched.

If the light flashes on and off, then goes out. Relays will have to be installed in fog lamp and reverse lamp circuit.

10. Disconnect negative battery terminal.

11. Two Relays required for fog and reverse lamps.

12. Relays mounted using existing holes in body with bolt and nut.

Label relays for easy diagnoses

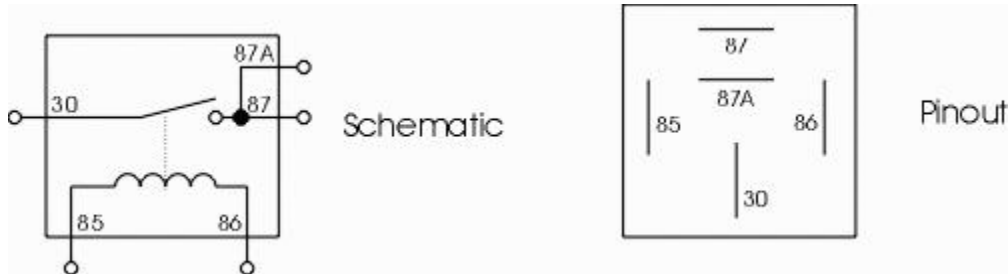

Pin 86 to Connector CA052 terminal 1 (black).

Pin 87 to Connector CA052 terminal 3 (white/red)

FOG LAMP.

Pin 85 cut and crimp wire about 2 inches from Grey connector BL001 OY (ORANGE / YELLOW).

Crimp wires.

Pin 30 crimp wires to BL001 OY (ORANGE / YELLOW) going to trunk lid harness.

REVERSE LAMP.

Pin 85 cut and crimp wire about 3 inches from Grey connector OG (ORANGE/GREEN)

Crimp wires.

Pin 30 crimp wires OG (ORANGE/GREEN) going to trunk lid harness.

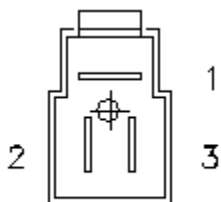

1. Terminal B (black) ground to relays pin 86.

2. Terminal N (brown) Not used

3. Terminal WR (white/red) fused at AJB.  
Power source for relays pin 87.

Connector BL001

If fog lamp turns on  
Reverse lamp.  
Switch wire  
2 OY and 3 OG

1 NR (BROWN/RED)

2 OY (ORANGE/YELLOW) Fog lamp circuit.

3 OG (ORANGE/GREEN) Reverse lamp circuit.

4 RG (RED/GREEN)

5 U (BLUE)

6 B (BLACK)

7 BW (BLACK/WHITE)

8 BG (BLACK/ GREEN)

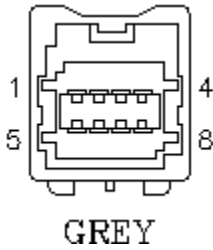



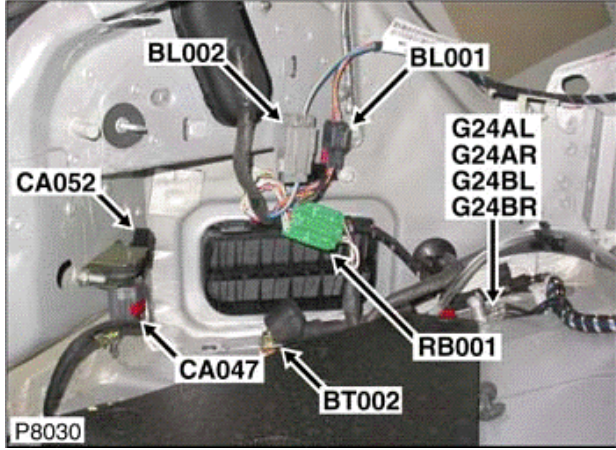

I

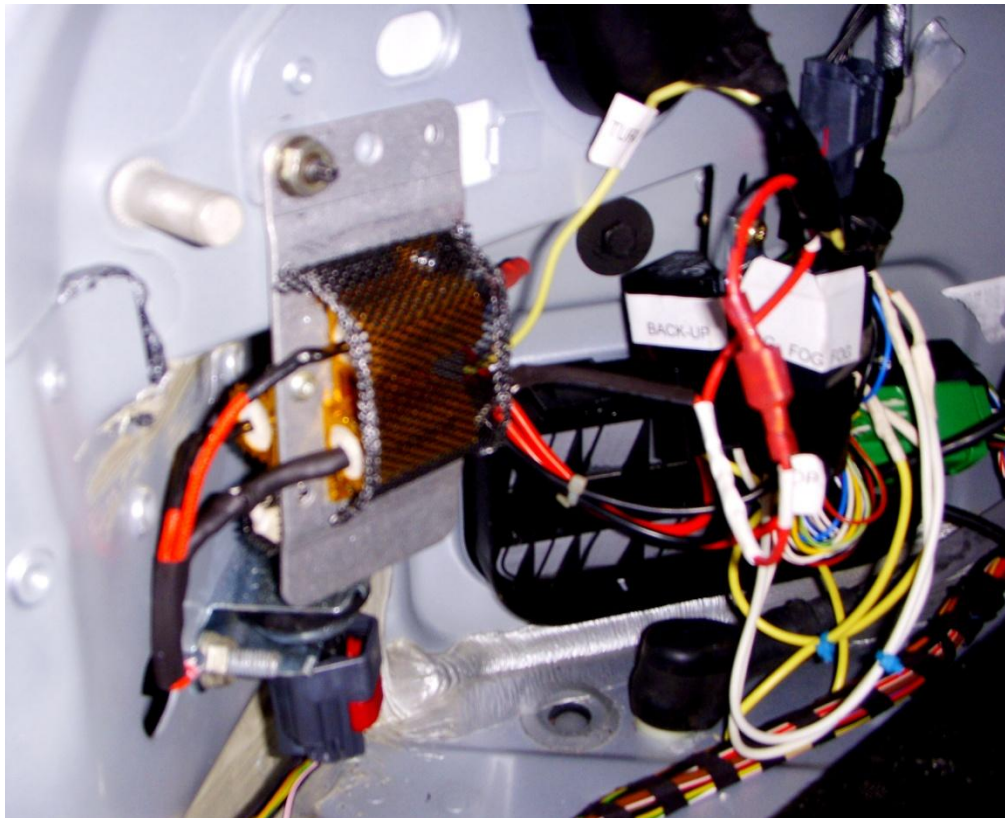

## 14. Tail lamp removal.

• NOTE: Take great care when removing the rear lamp assembly as the forward point of the lens can be easily damaged.

1. Remove the luggage compartment grille.
  - Release the clip.

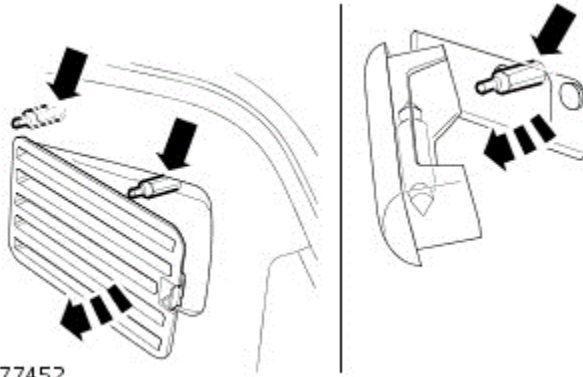

E77452

2. If installed, remove the loadspace lamp.
  - Disconnect the electrical connector.

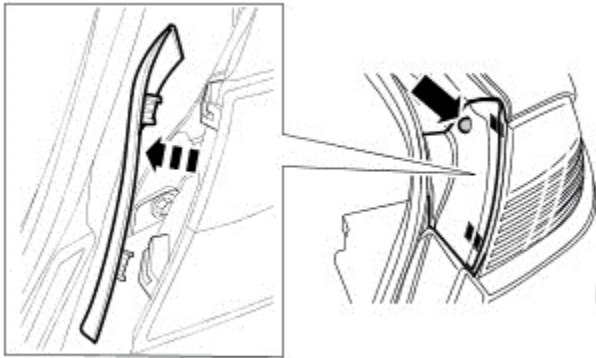

E77453

### 3.

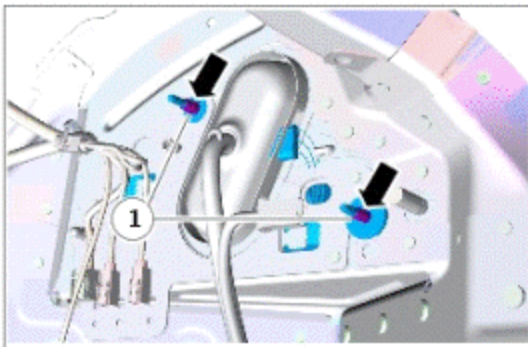

**CAUTION:** Note the fitted position of the component prior to removal.  
Remove the rear lamp assembly trim panel.

- Release the 3 clips.

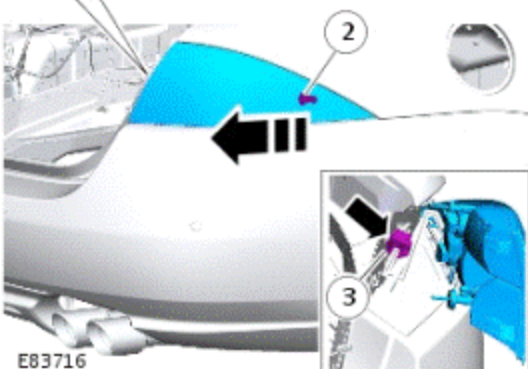

E83716



4.



CAUTION: Take great care when removing the rear lamp assembly as the forward point of the lens can be easily damaged.

Remove the rear lamp assembly.

- Remove the 2 nuts.
- Carefully release the clip.
- Disconnect the electrical connector.

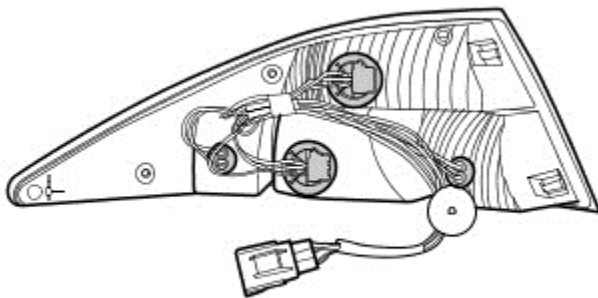

E77455

5. NOTE: Do not disassemble further if the component is removed for access only.



Remove the wiring harness.

- Release the 4 bulb holders.

Installation

**1.** Install the wiring harness

- Install the bulb holders.

**2.** NOTE: Align to the position noted on removal.

Install the rear lamp assembly.

- Tighten the nuts to 2 Nm (1.5 lb.ft).
- Connect the electrical connector.

**3.** NOTE: Position the rear lamp assembly trim panel upper edge behind the rear quarter panel lip.

Install the rear lamp assembly trim panel.

- Secure with the clips.

**4.** Install the trunk lamp.

**5.** Install the grille.



2007 lamp fastener

2010 lamp thread



Locating ground wire

NOTICE: PIN TERMINALS IS IN DIFFERENT LOCATION ON CONNECTOR FOR 2010 LAMPS.

USE 2007 PIN TERMINAL LOCATION.

LABEL WIRES TO AVOID CONFUSION.

CHANGE THE TERMINALS ON VEHICLE HARNESS SIDE. (FEMALE TERMINALS)

SERVICE EASE: IF THE LAMPS EVER NEEDS REPLACEMENT.



## RIGHT TAIL LAMP



2007

CA049 RIGHT LAMP

1	GB GREEN/BLACK		1	GB GREEN/BLACK	TAIL LIGHTS
2	GB GREEN/BLACK				OPEN
3	B BLACK		3		GROUND
4	W WHITE		4		STOP
5	U BLUE		5		TURN
6	OY ORANGE/YELLOW		6		SIDE MARKER L

2010 LAMP WIRES ARE ALL BLACK.

CONNECTOR CHANGE PINS (RED) TO -----2007

1	GN GREEN/BLACK		1		TAIL LIGHTS
2	WHITE		4	WHITE	STOP
3	BLANK (NO TERMINAL)	INSTALL >>>>	3	BLACK	GROUND
4	U BLUE	TURN	5		TURN
5	BK BLACK	GROUND	2		OPEN
6	OG/YE ORANGE/ YELLOW		6		SIDE MARKER L

LEFT TAIL LAMP

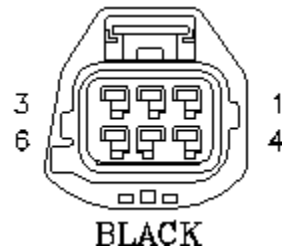

2007 LAMP

1	GN GREEN				TAIL LIGHTS
2	GN GREEN				TAIL LIGHTS
3	B BLACK				GROUND
4	O ORANGE				STOP
5	O ORANGE				TURN
6	OG ORANGE/GREEN				SIDE MARKER L

2010 LAMP.NOTE: all black

1	GN GREEN		1		TAIL LIGHTS
2	WHITE		4	ORANGE	STOP

3	BLANK (NO TERMINAL)	INSTALL >>>>	3	BLACK	GROUND
4	U BLUE	TURN	5	ORANGE	TURN
5	BK BLACK	GROUND	2		OPEN
6	O/G ORANGE/ GREEN		6		SIDE MARKER L

CHANGE PINS ACCORDLY.

16. LUBE CONNECTOR OF SILCONE GEL AND CONNECT. TEST: LIGHTS, STOP, TURN SIGNALS. WORKING PROPERLY?



LOAD RESISTOR.

17. 2 required CERAMIC RESISTORS 10 WATT 10 OHMS.

6 required 25 WATT 25 OHM LOAD RESISTOR.

2 required LOAD RESISTOR BRACKETS.

WIRE MESH SCREEN FOR HEAT SHIELD.

HEAT SHRINK TUBING

CONNECTOR CRIMPS. FOR GROUND CONNECTION.

RED LEAD FOR TURN SIGNAL. 2 25 WATT 25 OHMS CONNECT PARRELL CIRCUIT.

BLACK LEAD FOR STOP LAMP. 1 25 WATT 25 OHMS, 1 10 WATT 10 OHMS PARRELL CIRCUIT.

LOAD RESISTORS. FRONT SIDE

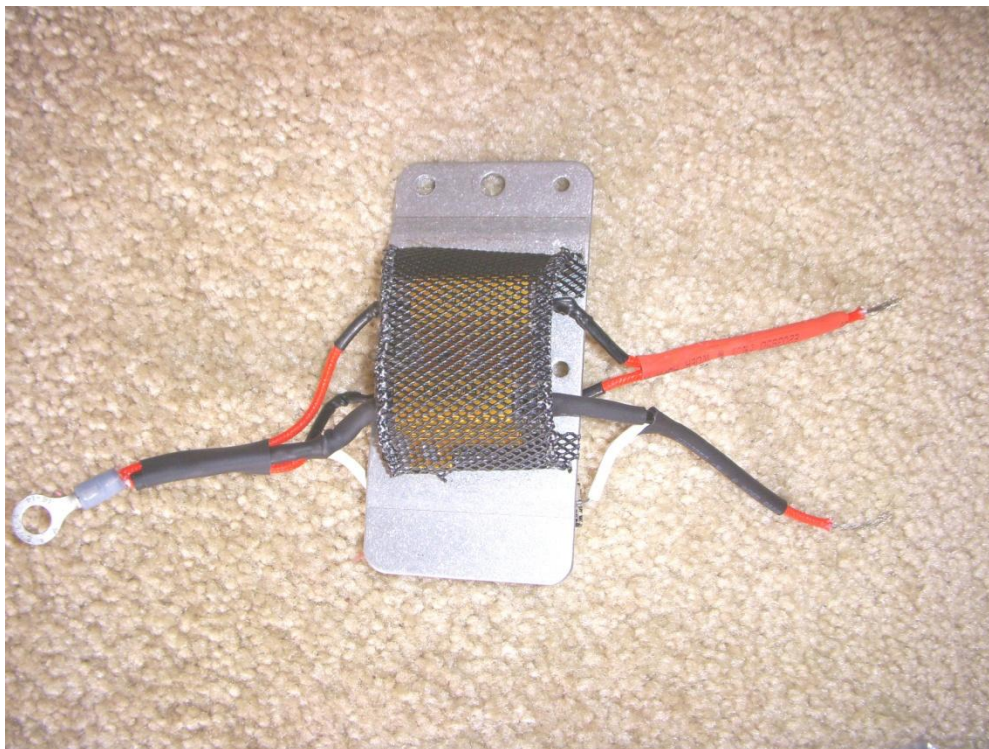

BACK SIDE.

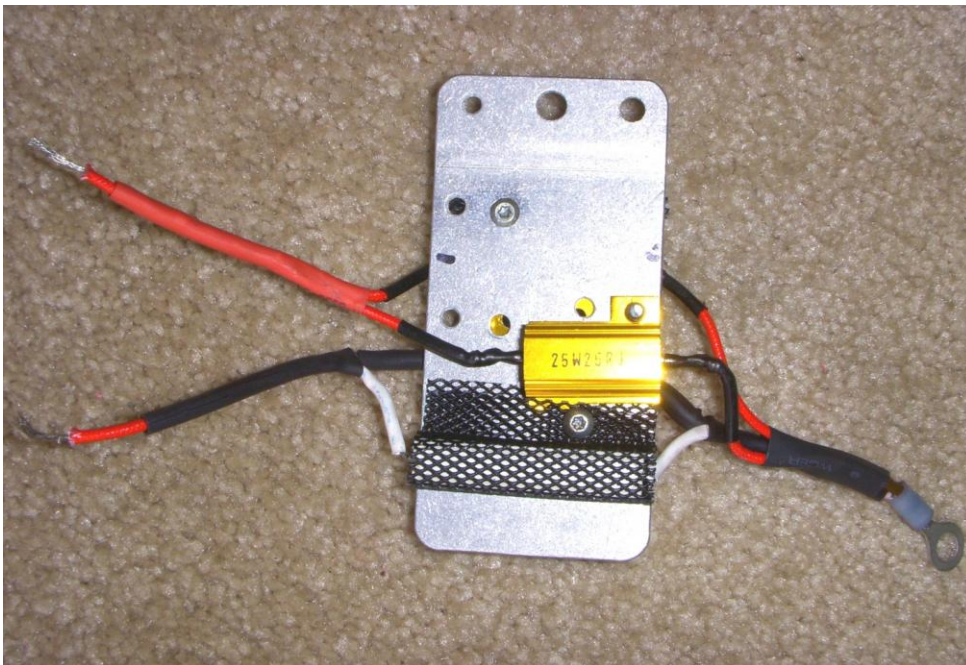

Use male installed crimp connectors for turn signals and stop lamps circuits.

Ring crimp terminal for ground.





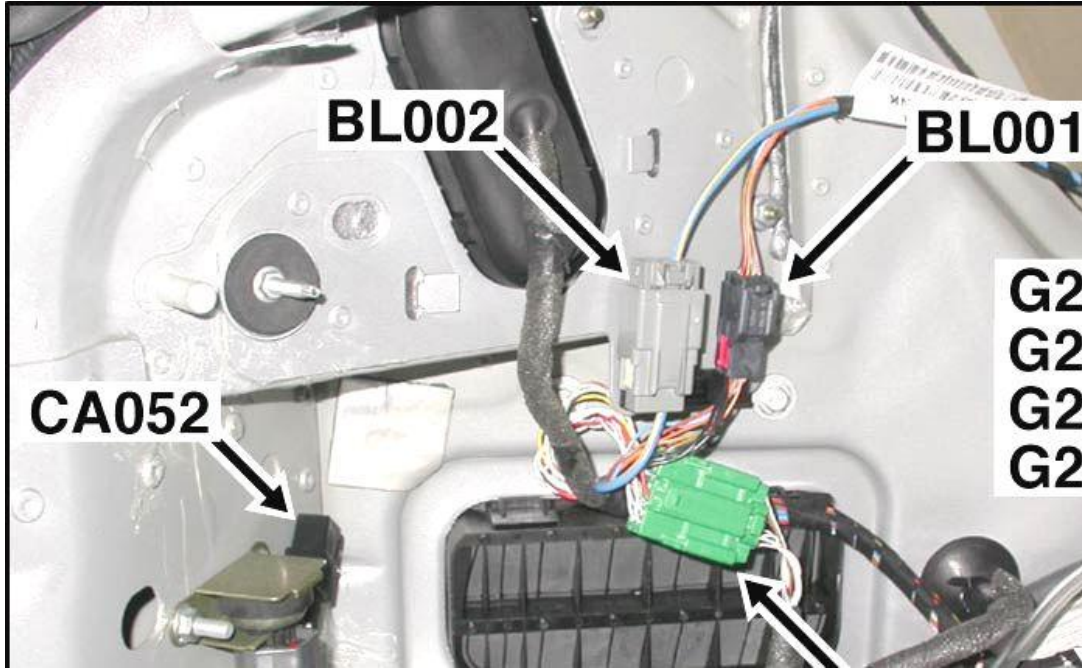

LEFT SIDE

REMOVE INSUALTION TAPE FROM HARNESS COMING FROM TAIL LAMP.

EXPOSE WIRES. LOCATE ORANGE WIRES **(NOTE: THERE IS TWO ORANGE WIRES. ONE FOR STOP LAMP CIRCUIT AND THE OTHER FOR TURN SIGNAL CIRCUIT.)**

**DO NOT CUT WIRES. USE: Quick Splice Connector with Male Disconnecter.**



**Quick Splice Connector with Male Disconnecter (3-Pack)**

**Model: 64878006D, MDFNY1-250 | Catalog #: 64-037**

TEST WITH VOLT METER TO SEE IF YOU HAVE TURN SIGNAL CIRCUIT.

CONNECT THE 2 25 WATT 25 OHM RESISTOR.

THE OTHER ORANGE SHOULD BE STOP LAMP CIRCUIT.

CONNECT 1 25 WATT 25 OHM AND 1 10 WATT 10 OHM.

TEST STOP LAMP AND TURN SIGNAL.

18. REPEAT THE SAME PROCESS ON THE RIGHT SIDE.

RIGHT SIDE STOP LAMP WIRING IS WHITE.

RIGHT SIDE TURN SIGNAL WIRING IS BLUE.

19. TEST LIGHTS: TURN SIGNAL SHOULD FLASH AT NORMAL SPEED.

NO WARNING MESSAGE SHOULD BE DISPLAYED.

20. TEST BRAKE LIGHTS.

NO WARNING MESSAGE SHOULD APPEAR.

21. DOUBLE CHECK WIRES FOR PROPER INSTALLATION. KEEP WIRES AWAY FROM LOAD RESISTOR. MAKE SURE THE RESISTORS HAVE HEAT SHEILD INSTALLED TO PREVENT BURNS OR FIRE.

22. Test drive. Inspect. Reinstall trunk panel trim.

## Parts List

- 1. C2P16337 HARNESS
- 1. C2P21453 LAMP-CLUSTER
- 1. C2P21454 LAMP-CLUSTER
- 1. C2P21458 LAMP
- 1. C2P21459 LAMP

6 required: 25 ohm 25 watt load resistor.  
Left side, Right side  
Two for turn signals  
One for stop lamp.

 click image to view larger size



V-LEDS Part ID: LOAD\_RES\_25OHM  
# In Package: 2 Resistors  
4 Splice Taps

Pasted from <<http://www.v-leds.com/BlinkerWarning-Fix/Warning-Light-Fix/LED-BULB-OUT-WARNING-p4481145.html>>

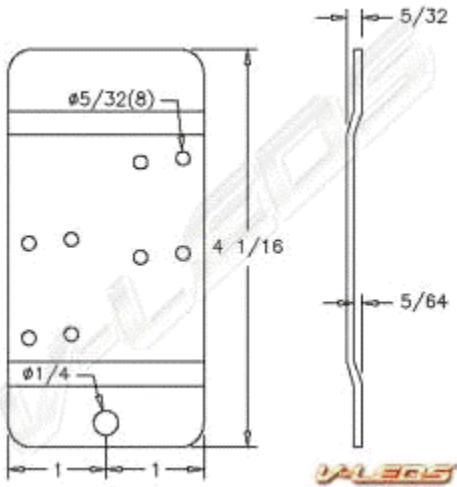

click image to view larger size

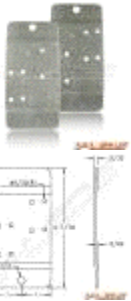

V-LEDs Part ID: RES\_PLATE\_DOUBLE  
 # In Package: 2 Plates

Pasted from <<http://www.v-leds.com/BlinkerWarning-Fix/Turn-Signal-Fix/2-LOAD-RESISTOR-MOUNTING-p6841378.html>>

-  
 Two 10 ohm 10 watt Load resistors for stop lamps.

## 10 Ohm 10W 5% Wirewound Resistor (2-Pack)

**Model:**

**271-132**

| **Catalog #:** 271-132

Pasted from <<http://www.radioshack.com/product/index.jsp?productId=2062291>>



## **Male/Female Insulated Quick-Disconnects (8-Pack)**

**Model:**

**64-3049**

| **Catalog #:** 64-3049

Pasted from <<http://www.radioshack.com/product/index.jsp?productId=2103499>>

## **Quick Splice Connector with Male Disconnecter (3-Pack)**



**Model:**

**64878106D,MDFNY2-250**

| **Catalog #:** 64-036

Pasted from <<http://www.radioshack.com/product/index.jsp?productId=3004023>>

## **Quick Splice Connector with Male Disconnecter (3-Pack)**

**Model:**

**64878006D,MDFNY1-250**

| **Catalog #:** 64-037

Pasted from <<http://www.radioshack.com/product/index.jsp?productId=2998435>>

## **1/4" Fully Insulated Quick Disconnects (10-Pack)**

**Model:**

## **64-3131**

| **Catalog #:** 64-3131

Pasted from <<http://www.radioshack.com/product/index.jsp?productId=2104016>>

## **6" Heat-Shrink Tubing (12-Pack)**

**Model:**

**278-1627**

| **Catalog #:** 278-1627

Pasted from <<http://www.radioshack.com/product/index.jsp?productId=2104090>>

## **20-Ft. 3/4" High Dielectric-Strength PVC Tape**

**Model:**

**64-2373**

| **Catalog #:** 64-2373

Pasted from <<http://www.radioshack.com/product/index.jsp?productId=2103347>>

### [Assorted Ring Tongues \(24-Pack\)](#)

Model: 64-3030 | Catalog #: 64-3030

Pasted from <<http://www.radioshack.com/search/index.jsp?kw=crimp+connector&pg=2>>

2 required for Fog and Back-up lights

- o [12 VDC Automotive Relay SPDT 30/40A](#)  
\$1.29
- o [12 VDC 5-PIN RELAY SOCKET](#)  
\$1.65

Pasted from <<http://www.amazon.com/VDC-Automotive-Relay-SPDT-40A/dp/B0002KR9GG>>

