

Floor Console 76.25.01

Removal

1. Position gear selector and passenger seat for access.
 - Turn ignition key to position II.
 - Apply footbrake and move gear selector to 'D'.
 - Release footbrake.
 - Power passenger seat to fully forward position and tilt squab forward.
 - Turn ignition key to O.
2. Remove battery cover and disconnect ground cable from battery terminal. Refer to <<86.15.19>>.
3. Remove 'J' gate surround. Refer to 76.25.24.

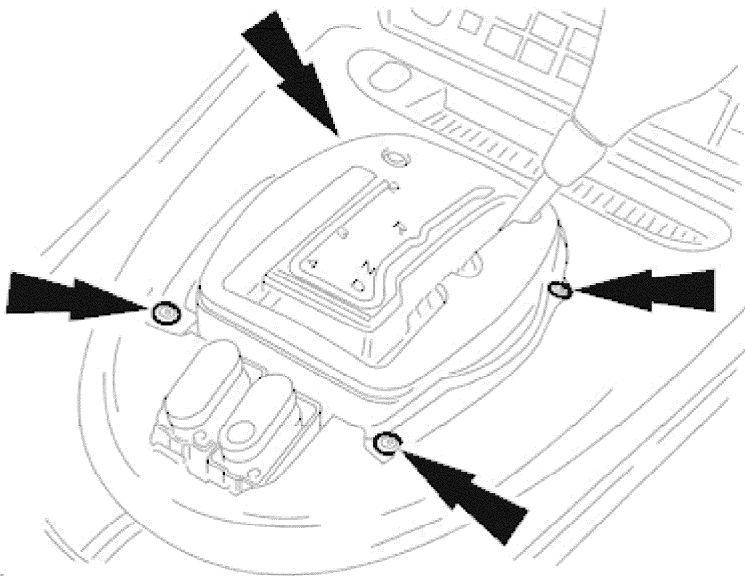

E36061

4. Slacken and remove the four center console veneer panel securing screws and remove the mounting plates.

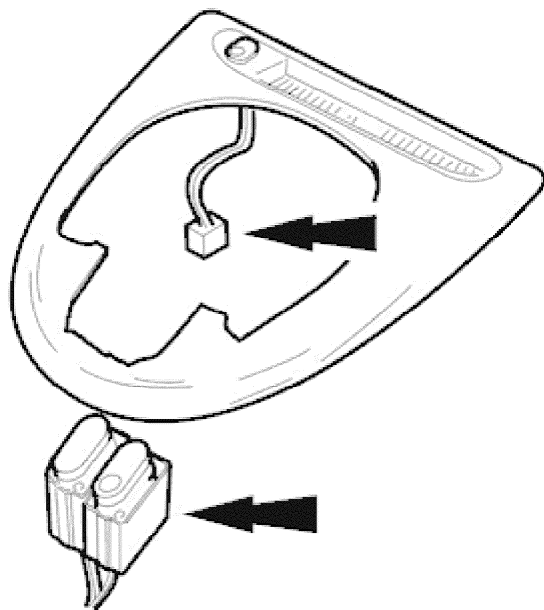

E34511

5. Position the veneer panel for access and disconnect the panel switch multiplugs.

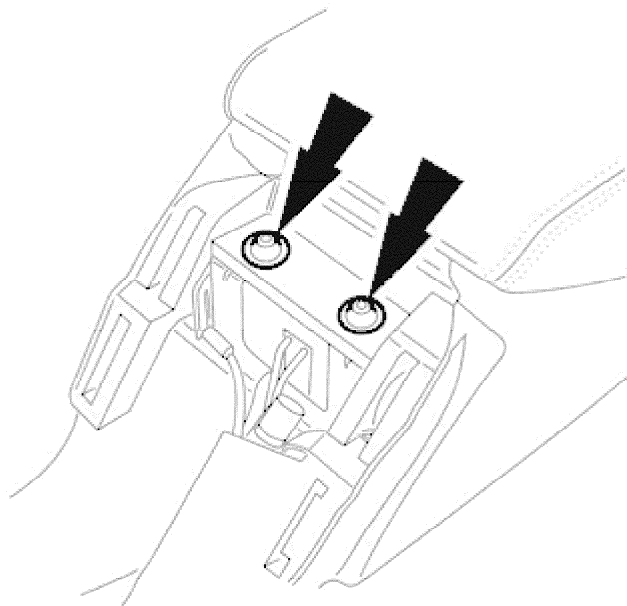

E35881

6. Remove console end trim cover and slacken and remove the two rear securing bolts.

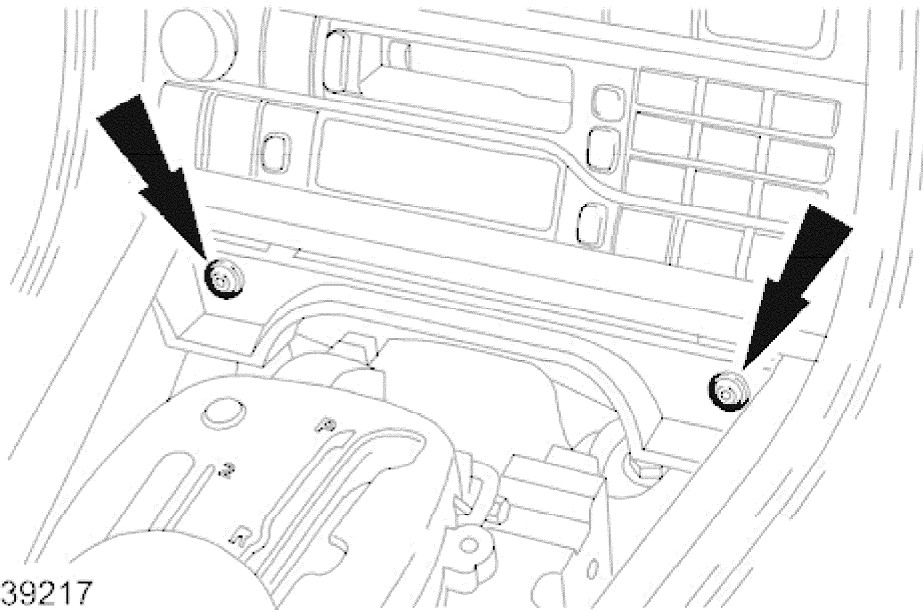

E39217

7. Slacken and remove the two forward securing bolts.

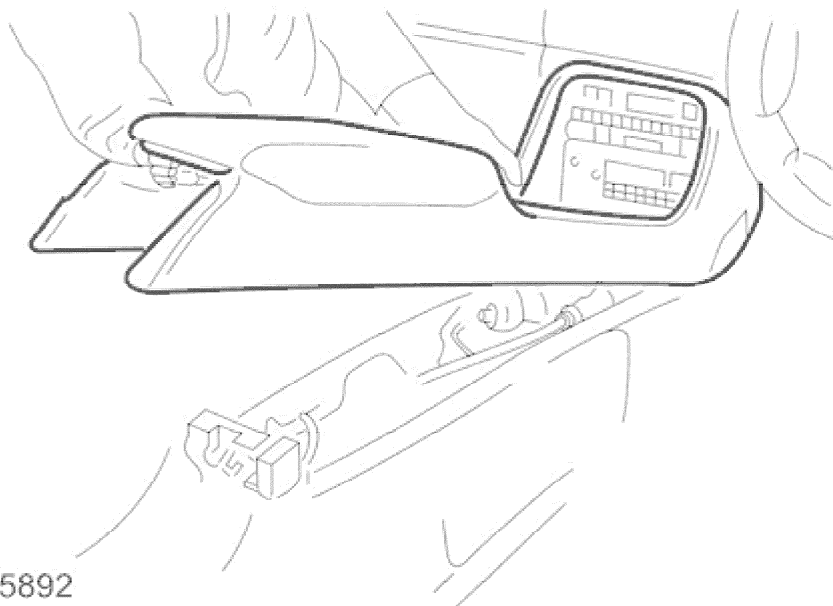

E35892

8. Position console for access, disconnect cigar lighter and valet switch harness multiplugs, lift console clear of 'J' gate and remove from vehicle.

Installation

1. Install and connect center console.
 - Position console for access.
 - Connect valet switch and cigar lighter harness multiplugs.
 - Finally position console.
 - Fit and tighten forward securing bolts.
 - Fit and tighten rear securing bolts.
 - Fit and fully seat console rear trim cover.

2003 XK RANGE - Instrument Panel and Console - 501-12

- Position veneer panel for access and connect panel switch harness multiplugs.
- Reposition and seat veneer panel.
- Align and fit panel mounting brackets.
- Fit and tighten panel securing screws.
- Fit 'J' gate surround. Refer to 76.25.24.
- Connect ground cable to battery terminal and fit battery cover. Refer to <<86.15.15>>.